

# Discovering the subcellular dynamics of life



## **ZEISS Lattice Lightsheet 7**

Long-term Volumetric Imaging of Living Cells

[zeiss.com/lattice-lightsheet](https://zeiss.com/lattice-lightsheet)



Seeing beyond

## Lattice light sheet technology readily accessible for your live cell imaging

- › In Brief
- › The Advantages
- › The Applications
- › The System
- › Technology and Details
- › Service

Light sheet fluorescence microscopy has become an established method for fast and unsurpassed gentle imaging of living specimens. By adding lattice structures to the light sheet, ZEISS Lattice Lightsheet 7 makes this technique available for live cell imaging at subcellular resolution – while also allowing you to use your standard sample carriers. With this automated, easy-to-use system the benefit of lattice light sheet microscopy – volumetric imaging of subcellular structures and dynamics over hours and days with best protection from photo damage – becomes available to everyone.

Thanks to the integrated auto-alignment procedure, you are ready to start your experiments within minutes. The inverted platform is compatible with all sample carriers commonly used for high-resolution optical microscopy. Examine the samples you already use for confocal microscopy experiments, without having to adjust your usual sample preparation. Discover the dynamics of life in unprecedented depth of detail – with the ease you never imagined possible!

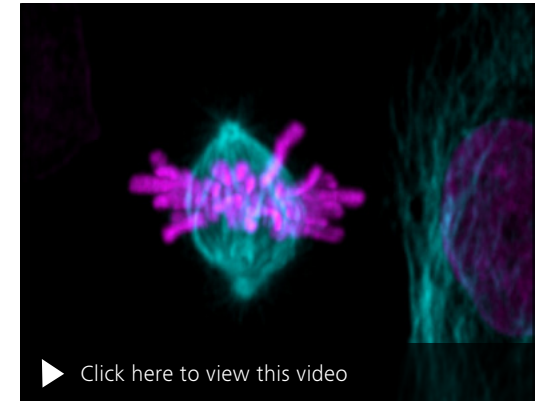
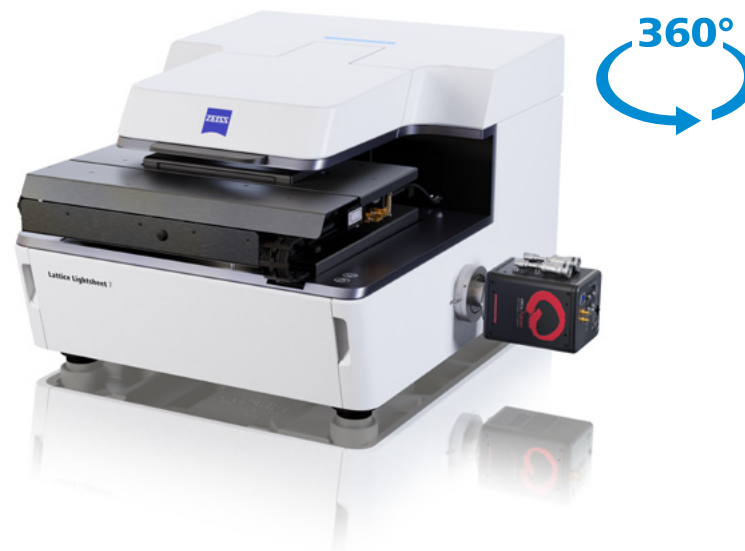

*LLC-PK1 cell undergoing mitosis. Cells are expressing H2B-mCherry (magenta) and  $\alpha$ -Tubulin mEGFP (cyan).*

# Simpler. More Intelligent. More Integrated.

- › In Brief
- › **The Advantages**
- › The Applications
- › The System
- › Technology and Details
- › Service

## Lattice light sheet technology made accessible to everyone

The importance of gentle light sheet imaging at high resolution cannot be overestimated for the study of subcellular processes. With Lattice Lightsheet 7, ZEISS makes access to the benefits of this advanced technology amazingly simple. Without having to adapt your usual sample preparation, you can examine living specimens directly on the standard sample carriers you already use for confocal microscopy. Complex alignment processes are performed automatically in this system, so that you can fully concentrate on your experiments.



Access lattice light sheet imaging with your standard cell culture dishes and coverslips.

## Next to no phototoxicity and bleaching

You want to watch the dynamics of life at sub-cellular resolution to study how the finest structures change over time, but your conventional imaging systems quickly reach their limits because they are too invasive and destroy what you are observing. Instead, ZEISS Lattice Lightsheet 7 provides lattice-structured light that automatically adapts to your sensitive samples, resulting in a massive reduction of photobleaching and phototoxicity, to allow your experiments to continue over hours and even days. The controlled incubation environment and an integrated auto-immersion mechanism enable unattended long-term experiments.

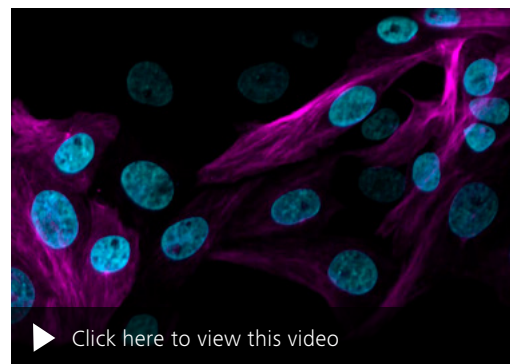

LLC-PK1 cell undergoing mitosis. Cells are expressing H2B-mCherry (cyan) and  $\alpha$ -Tubulin mEGFP (magenta). Recording over a period of 25 hours.

## High-speed volumetric imaging

The extremely fast image acquisition of ZEISS Lattice Lightsheet 7 enables up to three volume scans per second for each color channel. Dynamic imaging of full sample volumes with this high temporal resolution means no longer missing an interesting event on your coverslip. Near-isotropic resolution along the X, Y and Z axes gives you a three-dimensional image of your sample that reveals structural details in their true proportions. Two cameras and the specially designed excitation beam path allow for truly simultaneous imaging of two colors and quasi-simultaneous imaging of three colors.

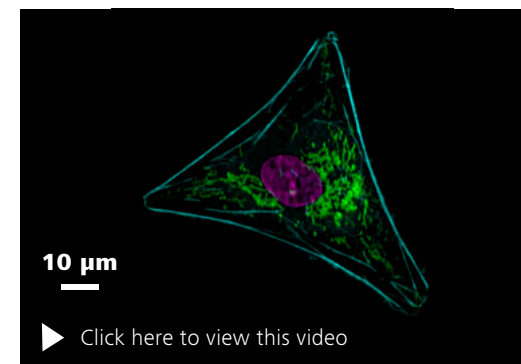

Time lapse movie showing dynamics of a U2OS cell stably expressing Actin-GFP (cytoskeleton, cyan). Cells were also labeled with MitoTracker™ Red CMXRos (Mitochondria, green) and Draq 5 (Nucleus, magenta).

# Your Insight into the Technology Behind It

- › In Brief
- › **The Advantages**
- › The Applications
- › The System
- › Technology and Details
- › Service

## The principle of lattice light sheet microscopy

Light sheet microscopy in general (also called Gaussian light sheet microscopy) is well known for its gentle imaging conditions at superior imaging speed.

The groundbreaking concept of decoupling excitation and detection allows illumination of only the part of the specimen that is in the focal plane of the detection objective lens. By moving the sheet with respect to the sample and recording one image per focal plane, you can acquire volumetric data without exposing the out-of-focus sample areas.

Lattice light sheet microscopy combines the advantages of light sheet microscopy with near-isotropic resolution in the confocal range. Advanced beam

shaping technology creates lattice-shaped light sheets that are significantly thinner than standard Gaussian light sheets and thus provide increased resolution at comparable imaging speeds. The lattice structure of the light sheet is created using a Spatial Light Modulator (SLM), then projected onto the sample after passing scanners that dither the lattice structure to create a smooth light sheet.

To allow imaging of horizontal samples such as standard cell culture dishes, excitation and detection objectives are oriented at an angle with respect to the sample. As a result, the sample is being illuminated and imaged from this angle.

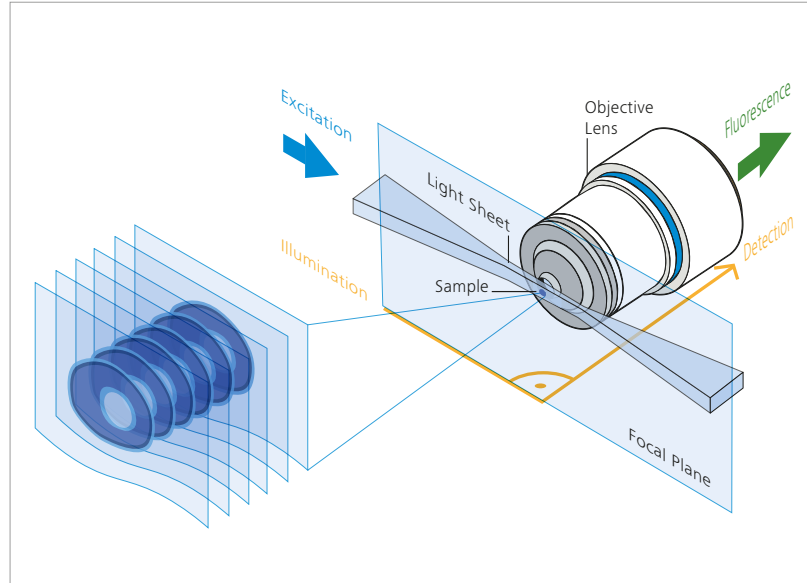

Conventional (Gaussian) light sheet microscopy splits fluorescence excitation and detection into two separate light paths, allowing to generate an inherent optical section by exciting only fluorescence from the in-focus plane.

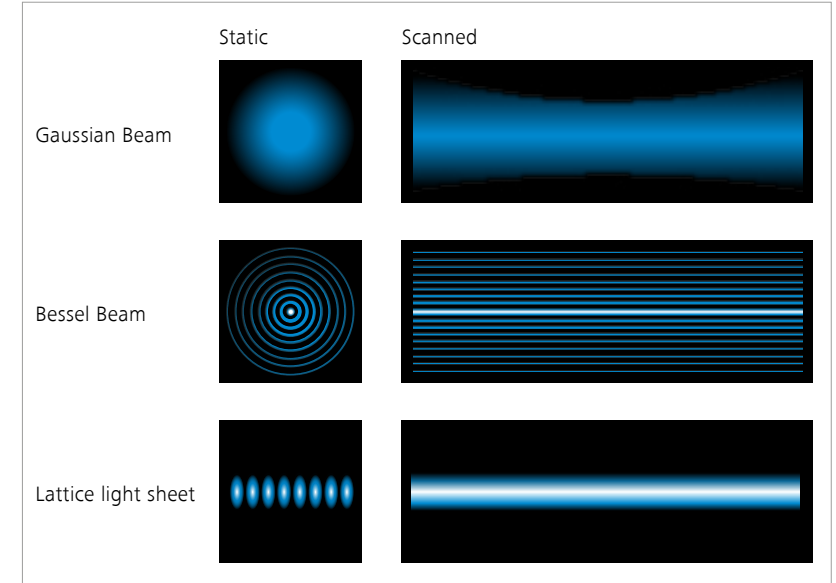

Lattice light sheet microscopy overcomes the limitations of Gaussian beams (limited optical sectioning, limited field of view) and Bessel beams (strong rings, excitation of out-of-focus fluorescence) by generating long and thin light sheets to achieve subcellular resolution.

# Your Insight into the Technology Behind It

- › In Brief
- › **The Advantages**
- › The Applications
- › The System
- › Technology and Details
- › Service

## The ZEISS implementation of lattice light sheet microscopy

During the development of Lattice Lightsheet 7, ZEISS gave special attention to user-friendliness and compatibility with conventional sample preparation techniques. An inverse configuration is the most important prerequisite to allow the use of standard sample carriers for high-resolution microscopy.

The challenges resulting from an inverse configuration are mainly refractive index mismatches as fluorescence is emitted from the sample, passes through aqueous cell culture media, a tilted glass coverslip and water immersion, then into the detection objective.

Special ZEISS optical elements in the proprietary detection beam path\* compensate for refractive index mismatches and enable you to image samples as easily and quickly as with a confocal microscope.



Schematic of sample carrier and core optics module with excitation objective (1), meniscus lens (2) and detection objective with free-form optics (3). Examples show imaging without (A) and with correction of refractive index changes (B).

\* Protected by patents CN109416462B, US11163147B2, US9964760B2

## Your Insight into the Technology Behind It

- › In Brief
- › **The Advantages**
- › The Applications
- › The System
- › Technology and Details
- › Service

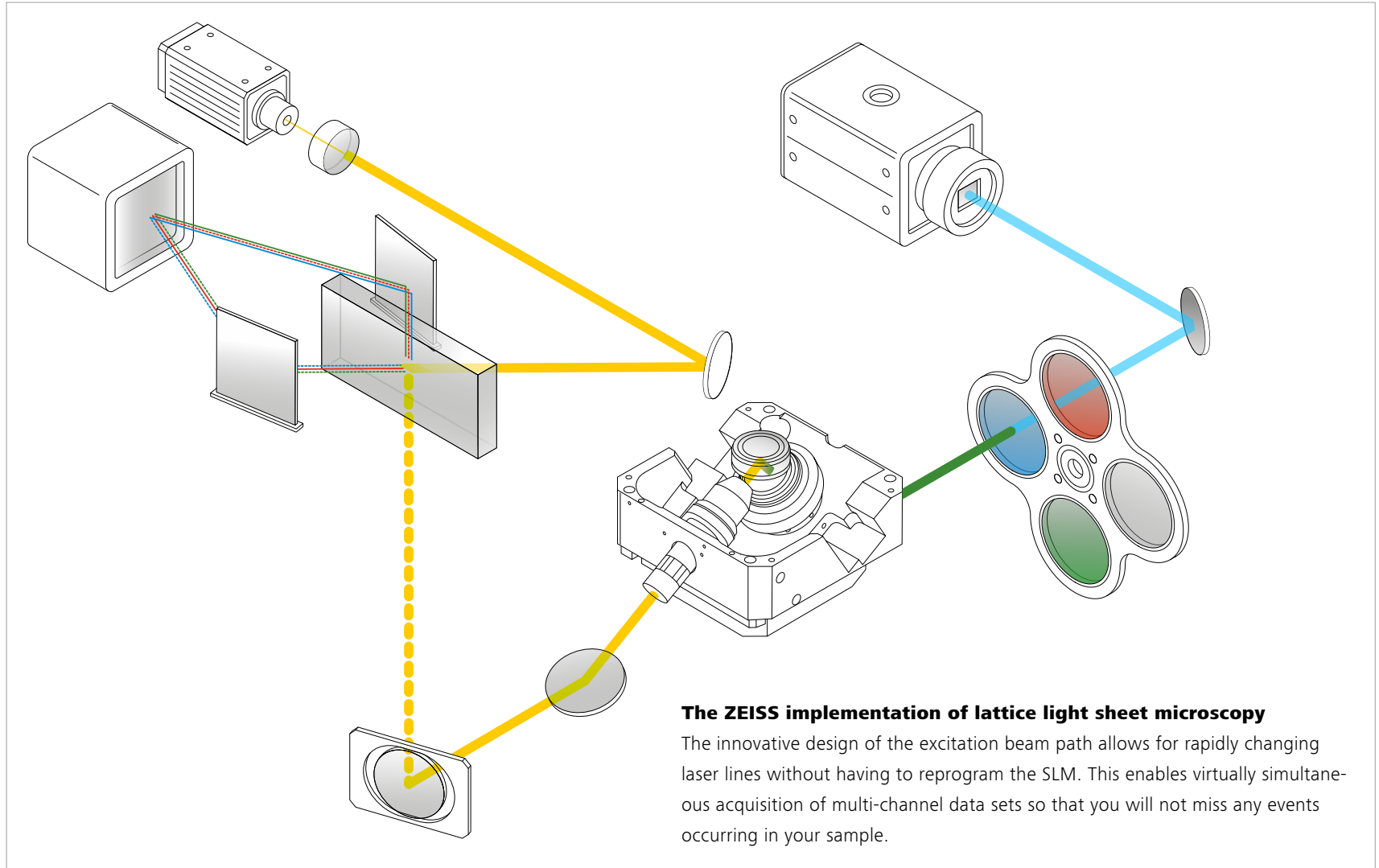

*Schematic of excitation beampath*

# Your Insight into the Technology Behind It

- › In Brief
- › **The Advantages**
- › The Applications
- › The System
- › Technology and Details
- › Service

## **A system that adapts to your samples – not the other way around**

ZEISS Lattice Lightsheet 7 can be used with all standard sample carriers that come with a no. 1.5 coverslip for the bottom. With the integrated transmission LEDs and oblique detection, which provide a DIC-like contrast, you can easily locate your sample. Change from white to red transmission LEDs for more gentle illumination if necessary.

Specifically designed for this system, the unique 5-axis stage not only allows movement along the X, Y and Z axes, but also tilting with the highest precision in X and Y. Leveling your sample is done automatically, which relieves you of tedious manual procedures.

For the best imaging results, the lattice light sheet must be adapted to each sample; therefore, ZEISS has implemented automatic alignment of all optical elements to eliminate time-consuming manual adjustments. The system is ready for imaging at the push of a button, ensuring a consistently efficient workflow. Your experiment startup procedure is accelerated, so you can spend your time on the more valuable data acquisition.

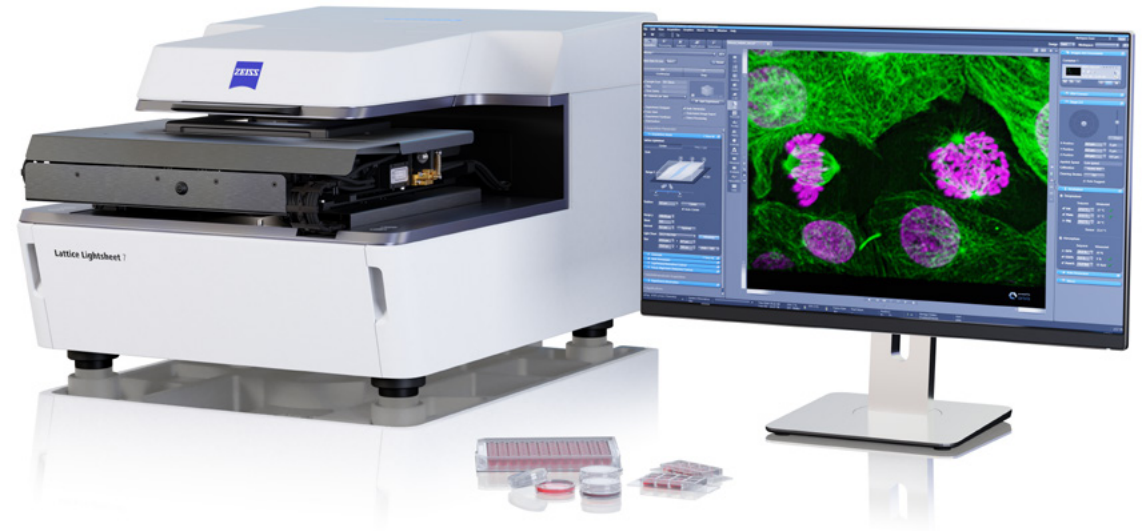

ZEISS Lattice Lightsheet 7 operates with our proven imaging software platform ZEN (blue edition). All features of this platform, such as advanced tiling and a powerful deconvolution algorithm, are conveniently at hand. The Direct Processing module allows you to process data during acquisition by streaming it to a separate PC.



▶ [Click here to view this video](#)

# Your Insight into the Technology Behind It

- › In Brief
- › **The Advantages**
- › The Applications
- › The System
- › Technology and Details
- › Service

## Lattice Lightsheet 7 with two cameras: Raise your experiments to new heights

With two cameras, you can double the temporal resolution at which you acquire your data. The innovative design of the excitation beam path allows simultaneous excitation of the sample with multiple laser lines. Combined with two cameras, this enables truly simultaneous imaging of two channels, which is critical for a range of applications such as ratiometric experiments.

A dual-camera setup also allows you to use single bandpass filters in front of each camera to minimize crosstalk and achieve cleanest results without compromising speed.



Lattice Lightsheet 7 equipped with two Hamamatsu ORCA-Fusion sCMOS cameras

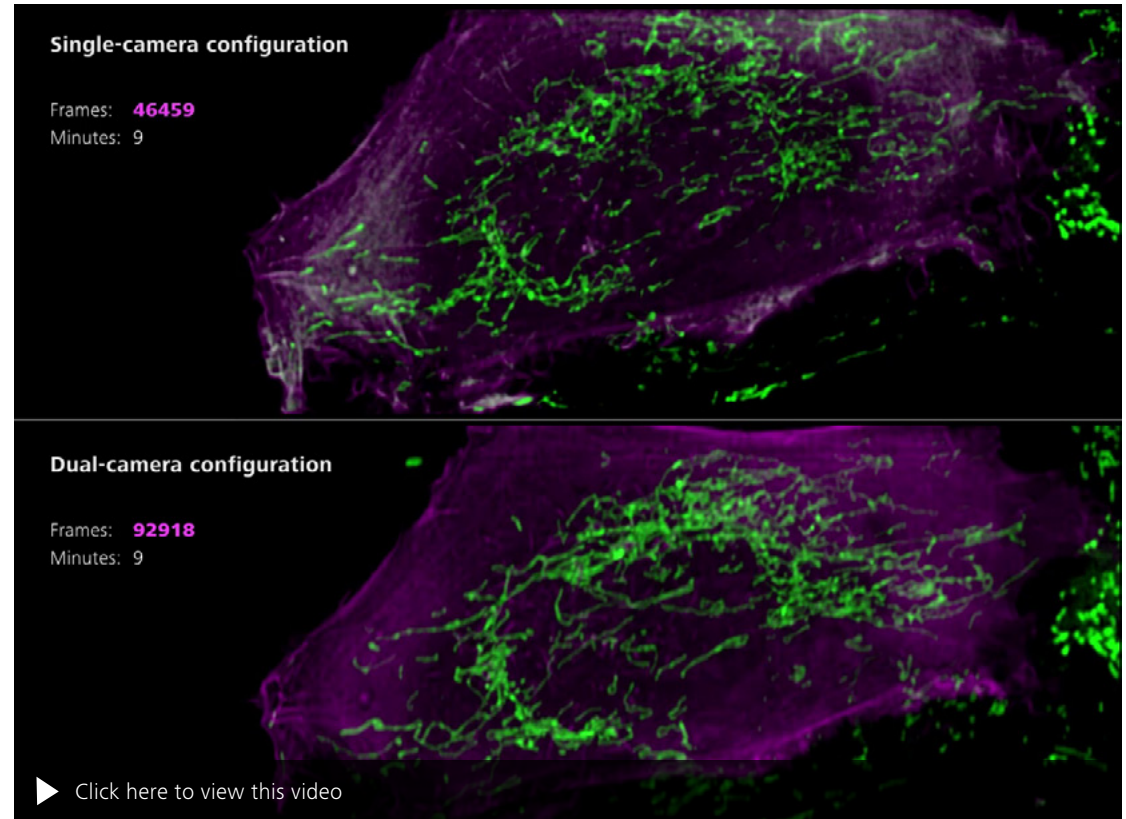

U2OS cells expressing Lifeact-tdTomato and stained with MitoTracker Green. Top row: single-camera configuration. When optimizing for speed, multi-bandpass filters must be used which can result in some crosstalk (whitish areas). Bottom row: dual-camera configuration. Crosstalk is minimized. In addition, twice as many images can be acquired, resulting in a doubling of temporal resolution.



## Your Insight into the Technology Behind It

- › In Brief
- › **The Advantages**
- › The Applications
- › The System
- › Technology and Details
- › Service

### Ready for unattended long-term experiments

An *ibidi* stage top incubation system is integrated into Lattice Lightsheet 7.

This system provides long-term stability throughout varying environmental conditions. The microscope controls and monitors temperature, CO<sub>2</sub> and O<sub>2</sub> levels, and humidity automatically, to preserve the integrity of your sample throughout the experiments. The lid with glass window allows quick and easy access to the sample to facilitate its inspection during an experimental run. And you can choose to include transmitted light illumination during long-term observations.

Prime the system to release any air, then a supply of immersion media tailored to the needs of your experiments is released automatically. Replenishing the immersion media is software-controlled, so you don't have to worry about interfering with image acquisition. The reservoir is protected from illumination to keep bacterial growth at bay. Objectives are shielded from immersion supply; hence they remain dry, even if excess immersion media is applied.

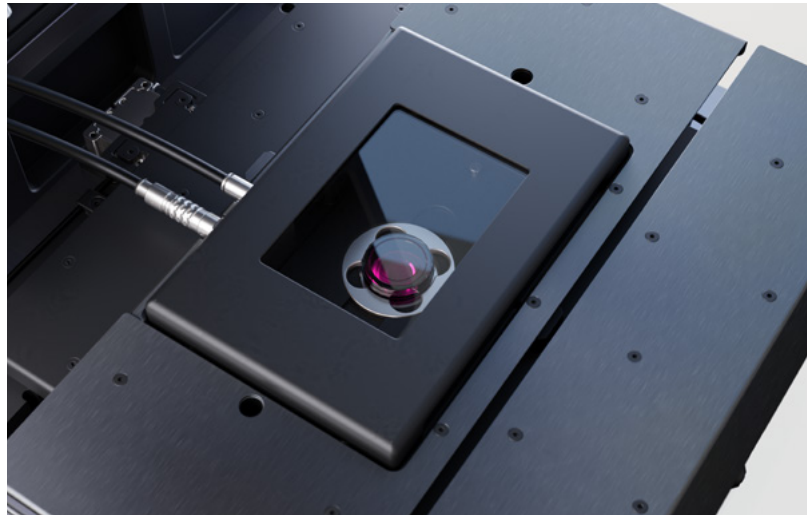

ZEISS Lattice Lightsheet 7 incubation chamber loaded with a standard 35 mm dish



ZEISS Lattice Lightsheet 7 autoimmersion equipment

## Your Insight into the Technology Behind It

- › In Brief
- › **The Advantages**
- › The Applications
- › The System
- › Technology and Details
- › Service

### Image Data Processing & Analysis

Your Lattice Lightsheet 7 uses ZEN (blue edition) imaging software for data processing, giving you the advantage of the platform's rich portfolio of image processing functionality. This includes ZEISS Lattice Lightsheet Processing tool including Deskewing, Cover Glass Transformation and DCV that can be arranged in a pipeline at your needs and many other benefits. With ZEN (blue edition) you can also easily image an extended area by tiles.

For the efficient handling of extremely large datasets and complex workflows, you can use arivis Vision4D®, bringing you added advantage of processing functions like advanced stitching, channel shift, high resolution volume rendering and much more so you can visualize and quantify your data in a quick, professional manner. arivis Vision4D®

is a modular software solution for working with multichannel 2D, 3D and 4D images of almost unlimited size, independent of available RAM. Your Lattice Lightsheet 7 generates huge multichannel datasets that can be handled without constraints by arivis Vision4D®, which runs on both the ZEISS Storage & Analysis PC and ACQUIFER HIVE.

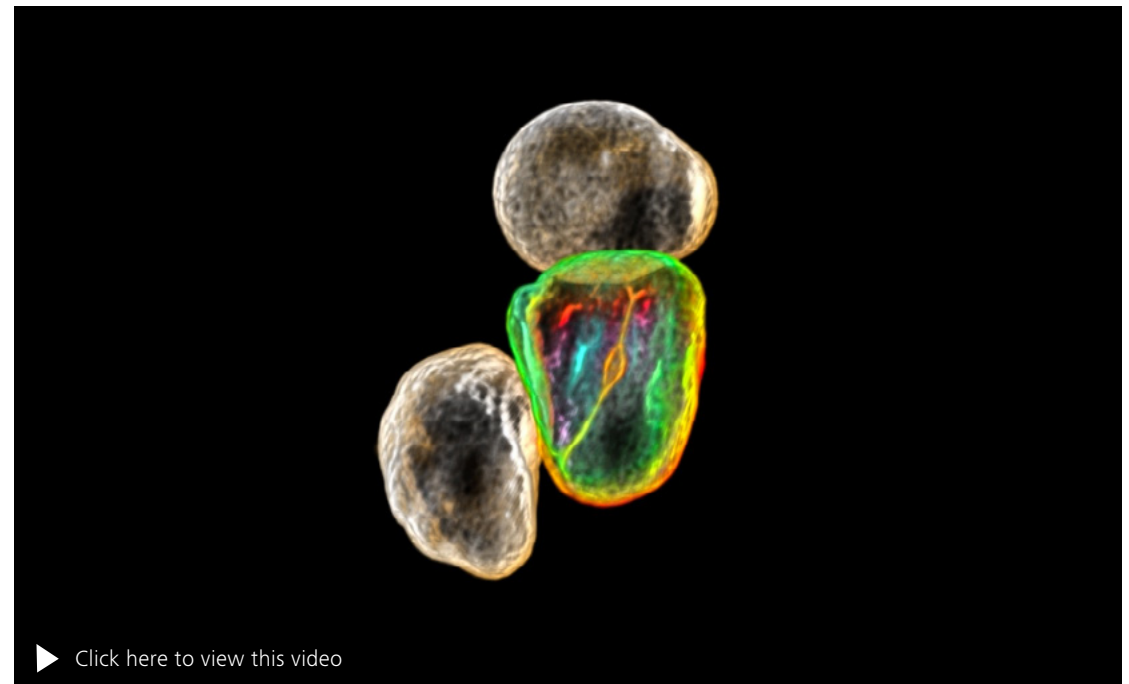
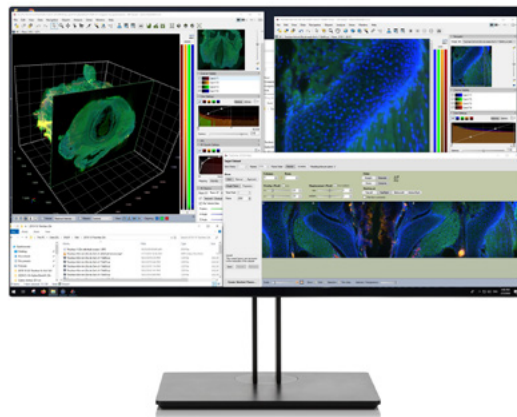

▶ [Click here to view this video](#)

*Human induced pluripotent stem cells. Images generated using AICS-0013 (LMNB1-mEGFP) from the Allen Institute for Cell Science.*

# Your Insight into the Technology Behind It

- › In Brief
- › **The Advantages**
- › The Applications
- › The System
- › Technology and Details
- › Service

## Large data storage and processing

With its high resolution and imaging speed, ZEISS Lattice Lightsheet 7 generates large datasets in a short period of time, which can place significant demands on your hardware. Data acquisition is supported by the same familiar storage system you know from our Lightsheet 7 instrument. Powerful Direct Processing and Batch Processing modules allow you to automate the processing task, so you can move on to other tasks and return when your imaging work is complete.

If more space is needed, Lattice Lightsheet 7 can be connected to your local server structure, or a scalable storage device like the HIVE from Acquirer, via the 10 GB data transfer lines. The HIVE offers the advantage of running ZEN image processing software, so its utility extends beyond simply image storage.

Imaging the sample at an angle requires that the data must be transformed before visualization and analysis. This process, commonly known as deskewing, is implemented in ZEN (blue edition). The Lattice Lightsheet Processing module allows you to combine individual processing steps into one task. You can customize the arrangement of and perform the required steps based on your

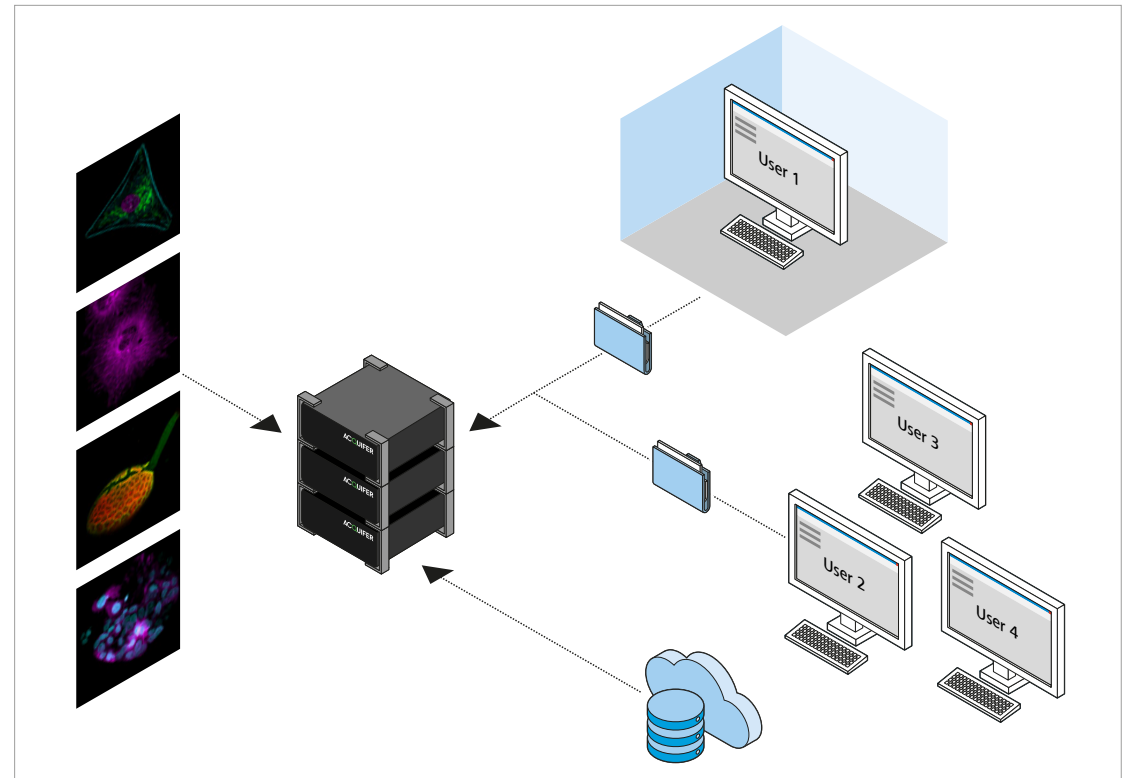

experiment needs. For example, select a coordinate transformation step to render the data set into a format familiar from your confocal and classical widefield imaging work so you never lose track of sample orientation. Or, choose the deconvolution feature to improve image quality

especially when you have chosen a thinner light sheet with pronounced side lobes. By arranging your choice of processing steps into individual pipelines within the Lattice Lightsheet Processing module, you are able to work faster for subsequent experiments.

# Tailored Precisely to Your Applications

- › In Brief
- › The Advantages
- › **The Applications**
- › The System
- › Technology and Details
- › Service

Perform experiments you would never have attempted before. ZEISS Lattice Lightsheet 7 with its large field of view and high-resolution detail allows you to observe subcellular structures and dynamics with high temporal resolution over extended time periods. Its unsurpassed gentle illumination ensures that your living samples are not damaged by phototoxicity and your experiments are not affected by photobleaching.

Typical Applications / Typical Samples	Task
<b>Live cell imaging of</b> ■ Adherent cells ■ Suspension cells	Volumetric imaging of subcellular processes with high speed: organelle morphology and dynamics, organelle-organelle interactions, vesicle trafficking Volumetric imaging of membrane dynamics Volumetric imaging of immune cells such as T cell mobility and activation Gentle imaging of live cells for hours up to days with minimal phototoxicity and photobleaching Cell proliferation and apoptosis assays
<b>3D cell culture</b> ■ Spheroids ■ Organoids ■ Cysts ■ Cells in Hydrogel	Live imaging of spheroids or organoids with diameters up to 200 $\mu\text{m}$ Organoid self-organization Cell migration and proliferation within organoids Imaging of cell-cell interactions, 3D organization, migration and morphology <i>In vitro</i> imaging of neuronal activity
<b>Small evolving organisms, e.g.</b> ■ Zebrafish embryos ■ C. elegans embryos ■ Drosophila embryos	Resolving structural detail in 3D with close to isotropic resolution Fast imaging of cellular and subcellular dynamics in embryos and small organisms up to 100 $\mu\text{m}$ in diameter Cell migration, cell-cell interaction, cell cycle, vesicle trafficking
<b>Oocytes</b>	Live imaging of whole oocytes in 3D with subcellular detail
<b>Expanded samples</b>	Water based gel expanded small samples

# ZEISS Lattice Lightsheet 7 at Work

- › In Brief
- › The Advantages
- › **The Applications**
- › The System
- › Technology and Details
- › Service

## Lamin B1 in action

Lamin B1 localizes to the nuclear envelope and is involved in disassembling and reforming the nuclear envelope during mitosis. The formation of so-called 'nuclear invaginations' has been reported frequently for many different cell types during mitotic events at different stages of the cell cycle. Nuclear invaginations can manifest as tubular structures that extend from the nuclear envelope and cross through the nucleus. Although these unique structures have been reported frequently, most research so far has been done with fixed cells. Consequently, the function of these structures is largely unknown even though plenty of hypotheses have been proposed.

This data set was recorded with a cell line from the Allen Institute for Cell Science in Seattle: human induced pluripotent stem cells which endogenously express mEGFP-tagged lamin B1 (AICS-0013). The overnight experiment was recorded for close to 8 hours with one volume imaged every 1.5 min. Cells going through mitosis can be observed throughout the whole duration. Formation and dynamics of nuclear invaginations can clearly be observed in most of the cells, throughout the complete cell cycle.

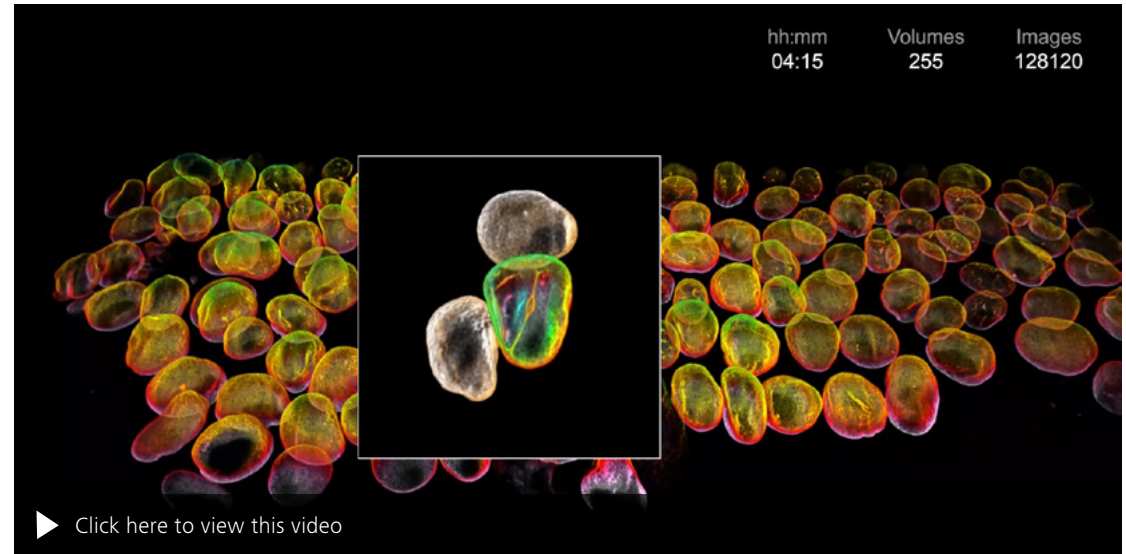

*Human induced pluripotent stem cells which endogenously express mEGFP-tagged lamin B1 (AICS-0013). Images generated using AICS-0013 (LMNB1-mEGFP) from the Allen Institute for Cell Science.*

Gentle illumination is crucial for imaging mitosis as this process is extremely delicate and light sensitive. To prevent replication of damaged DNA, cells arrest mitosis as soon as there is any damage from excitation light. The gentleness of Lattice Lightsheet 7 imaging and an extremely stable system is required for imaging mitotic events over longer time periods. Fast volumetric imaging in combination with near-isotropic resolution allows

for looking at the sample from every angle and investigating unique subcellular structures in every detail.

ZEISS Lattice Lightsheet 7 is the perfect tool for challenging experiments like this. Applications that were impossible before turn into reality – and with its ease of use, they can also become real for your research.

# ZEISS Lattice Lightsheet 7 at Work

- › In Brief
- › The Advantages
- › **The Applications**
- › The System
- › Technology and Details
- › Service

## Gently image subcellular dynamics at highest volume speed

Get the best of both worlds: lattice light sheet technology combines the speed and gentleness of light sheet microscopy with the resolution of confocal microscopy. The lattice light sheet illumination technique allows for extremely efficient illumination and, as a consequence, the gentlest imaging conditions.

COS-7 cell transiently transfected with Tomm20-mEmerald and Calreticulin-tdTomato. Tomm20 labels the outer membrane of mitochondria, Calreticulin is a protein of the ER where proteins are synthesized. Both are extremely delicate and light-sensitive organelles that are difficult to image with conventional methods. The example shows ER wrapping around mitochondria and assisting mitochondrial fission.

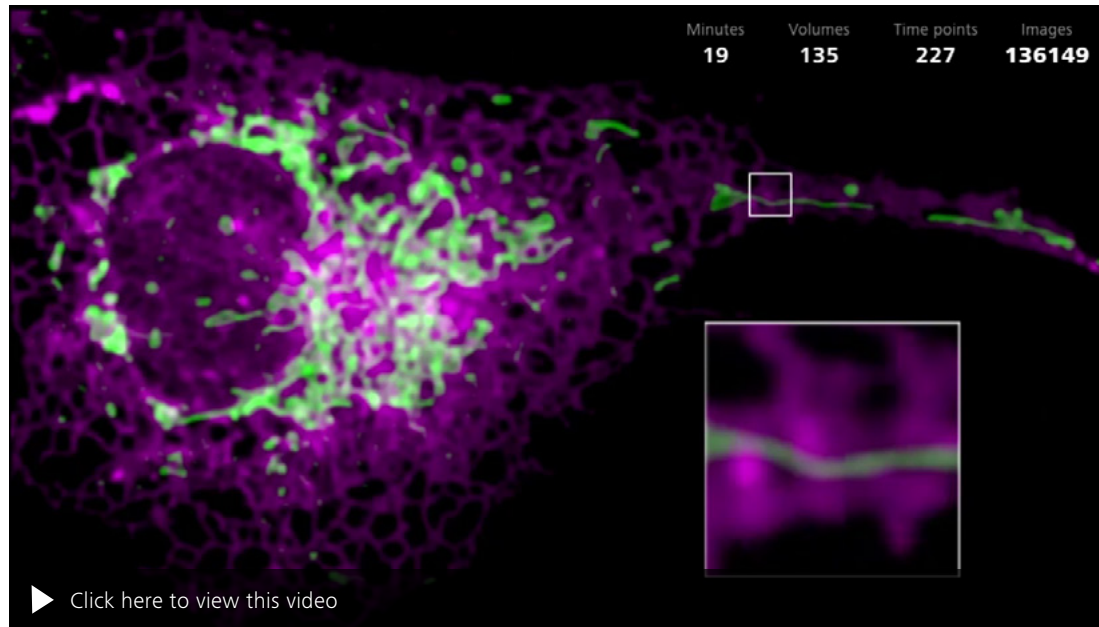

*One volume every 5 sec; continuous imaging for 43 mins; digitally zoomed-in region shown. Imaged volume:  $98 \times 141 \times 22 \mu\text{m}^3$ . A total of 301,000 images were recorded; 301 volume planes for 500 time points.*

COS-7 cells transiently transfected with Calnexin-mEmerald and EB3-tdTomato. EB3 labels the growing ends of microtubules and is necessary for the regulation of microtubule dynamics. Calnexin is a protein of the ER where proteins are synthesized.

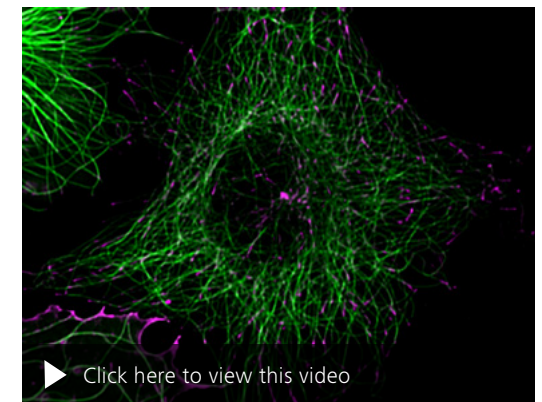

*One volume every 7 sec; continuous imaging for 24 mins; digitally zoomed-in region shown. Imaged volume:  $118 \times 113 \times 22 \mu\text{m}^3$ . A total of 240,600 images were recorded; 401 volume planes for 300 time points.*

# ZEISS Lattice Lightsheet 7 at Work

- › In Brief
- › The Advantages
- › **The Applications**
- › The System
- › Technology and Details
- › Service

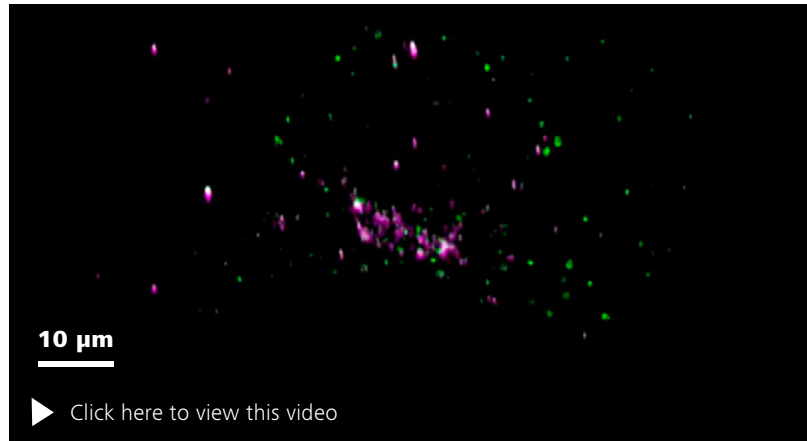

*COS-7 cells transiently transfected with mEmerald-Rab5a and Golgi7-tdTomato. Golgi7 is a protein associated to the Golgi and Golgi vesicles. Rab5a is an early endosome marker. Tracking of vesicles in 3D with near-isotropic resolution becomes reality. Tracking was performed in arivis Vision4D®.*

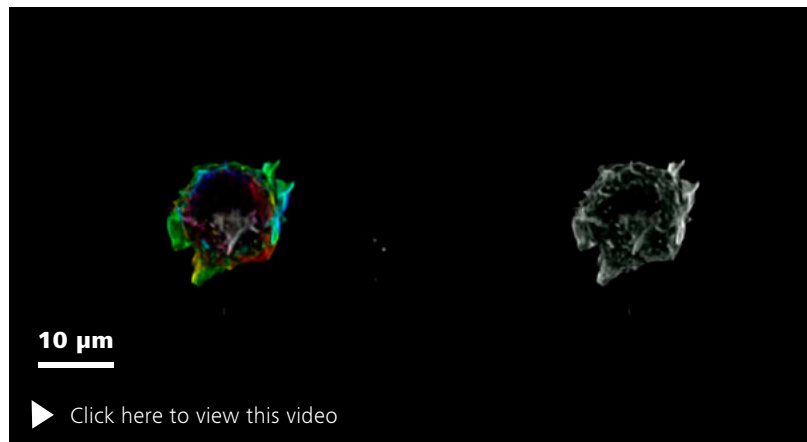
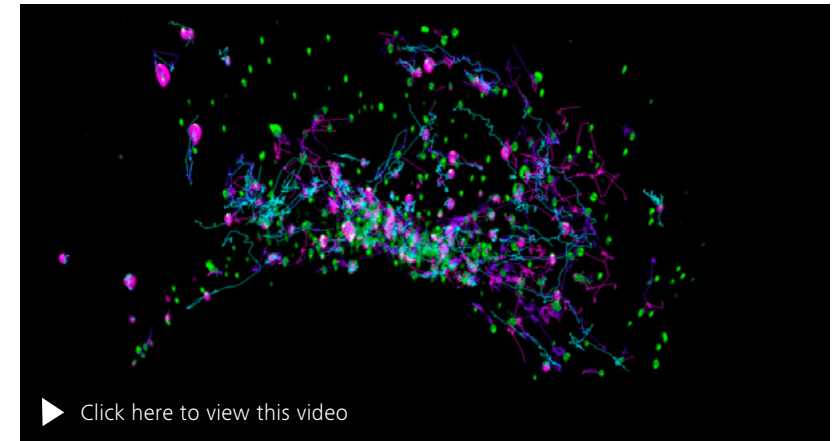

*T cell expressing Lifeact-GFP. Color-coded depth projection and maximum intensity projection side-by-side. The T cell was imaged constantly for over 1 hr; one volume every 2.5 secs. Sample courtesy of M. Fritzsche, University of Oxford, UK.*

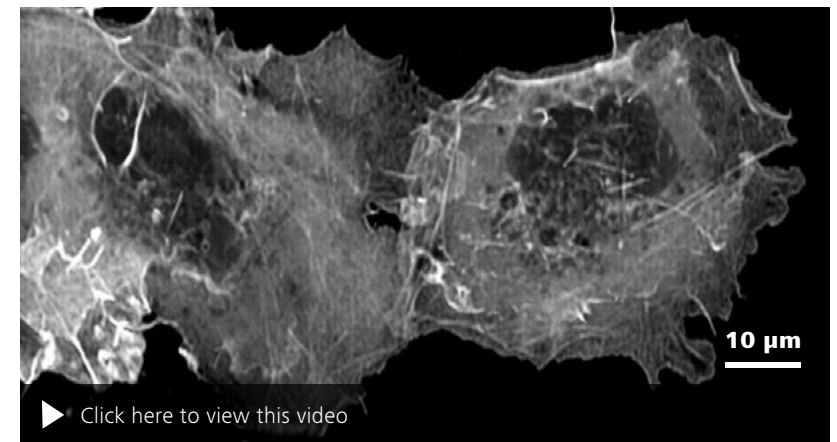

*COS-7 cell expressing Lifeact-GFP. Maximum intensity projection. The cell was imaged constantly for 9 hrs; one volume (115 × 60 × 25 μm<sup>3</sup>) every 10 secs. A total of 1,005,000 images was recorded; 201 volume planes for 5,000 time points.*

# ZEISS Lattice Lightsheet 7 at Work

- › In Brief
- › The Advantages
- › **The Applications**
- › The System
- › Technology and Details
- › Service

## Reliable investigation of co-localization

As you want to investigate co-localization, you can't afford any crosstalk to be confident the observed co-localization is real. However, the choice of using single-bandpass filters means you need to switch filters while imaging and this slows down the acquisition enough to cause significant shift between structures that you know should overlay. So, you can't be confident in the co-localization results and observed interactions.

A dual-camera setup solves this dilemma, giving you confidence in the acquired data and the results you can draw from it.

The movie on this page shows U2OS cells stained with MitoTracker Green (green) and MitoTracker Red CMXRos (magenta), two dyes that localize to mitochondria and should therefore always co-localize. The comparison shows data recorded with a single-camera setup (left) and a dual-camera setup (right).

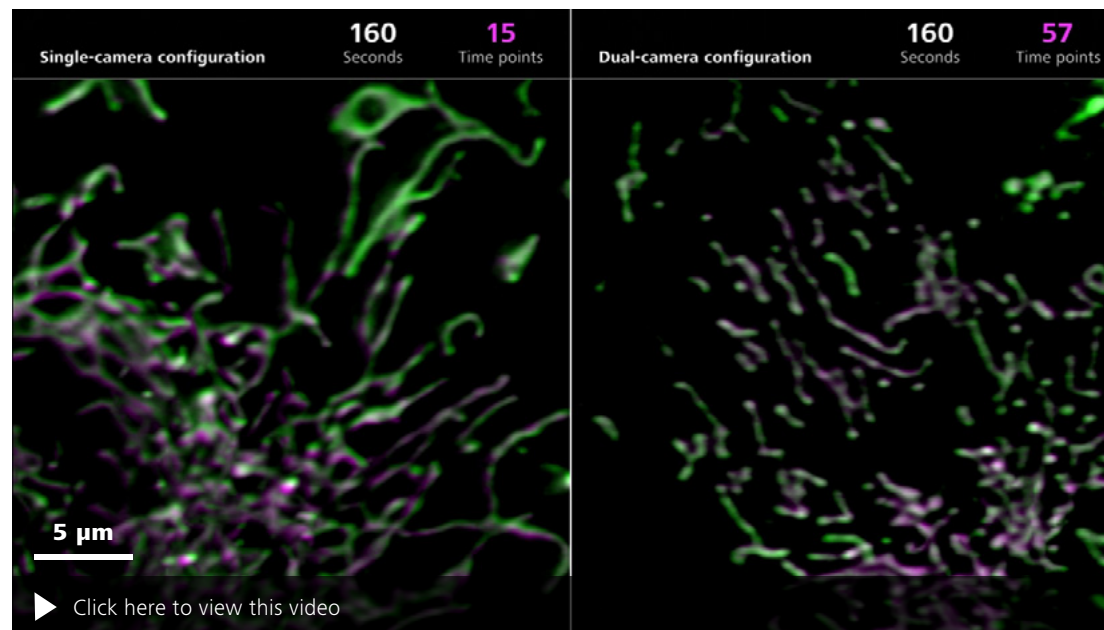

### Single-camera configuration

Single-bandpass filters had been used to remove potential crosstalk. A recording time delay between the two channels manifests in a spatial shift of the structures.

### Dual-camera configuration

The structures overlay completely as is to be expected. Also notice that the movie plays much smoother as 60 time points could be acquired. For comparison, with a single camera configuration, only 16 time points could be acquired within the same time.



# ZEISS Lattice Lightsheet 7 at Work

- › In Brief
- › The Advantages
- › **The Applications**
- › The System
- › Technology and Details
- › Service

## A dual-camera setup enables ratiometric experiments

The fluorescence intensity ratio of MitoTracker Green and MitoTracker Red CMXRos was analyzed to investigate mitochondrial membrane potential as only the uptake of MitoTracker Red CMXRos is membrane potential dependent; MitoTracker Green is a measure for mitochondrial mass but independent of mitochondrial membrane potential and can serve as internal reference. Thus, the fluorescence ratio of the two dyes is a relative measure of the mitochondrial membrane potential.\*

\*<https://pubmed.ncbi.nlm.nih.gov/15382028/>

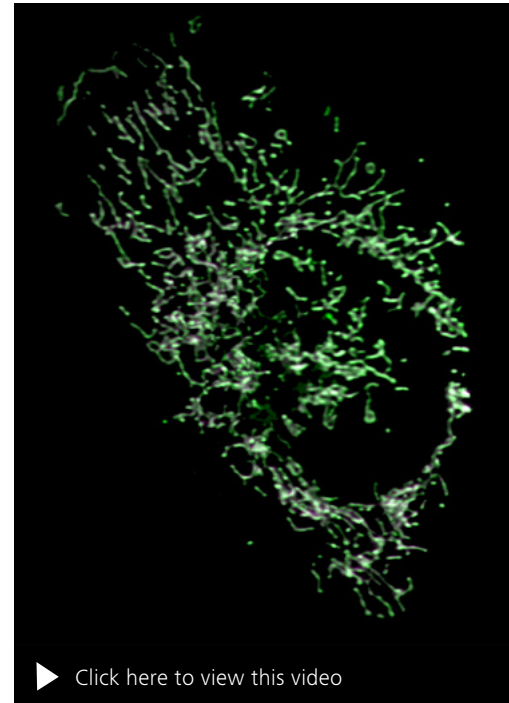

*U2OS cell stained with MitoTracker Green (green) and MitoTracker Red CMXRos (magenta)*

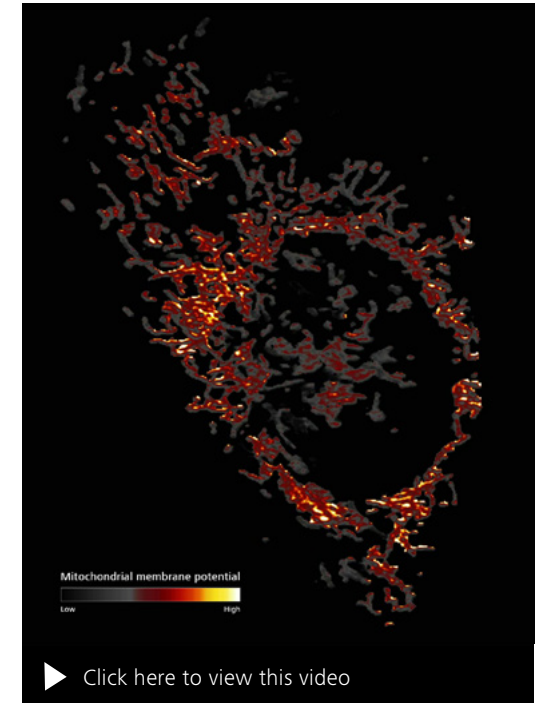

*Fluorescence intensity ratio of MitoTracker Green and MitoTracker Red CMXRos*

# ZEISS Lattice Lightsheet 7 at Work

- › In Brief
- › The Advantages
- › **The Applications**
- › The System
- › Technology and Details
- › Service

## Combine high speed with gentleness

Get the best of both worlds: Lattice Lightsheet 7 with the Hamamatsu ORCA-Fusion camera allows you continuous imaging with high speed over multiple hours – so you can watch delicate processes like mitosis without missing the finest details or the fastest events.

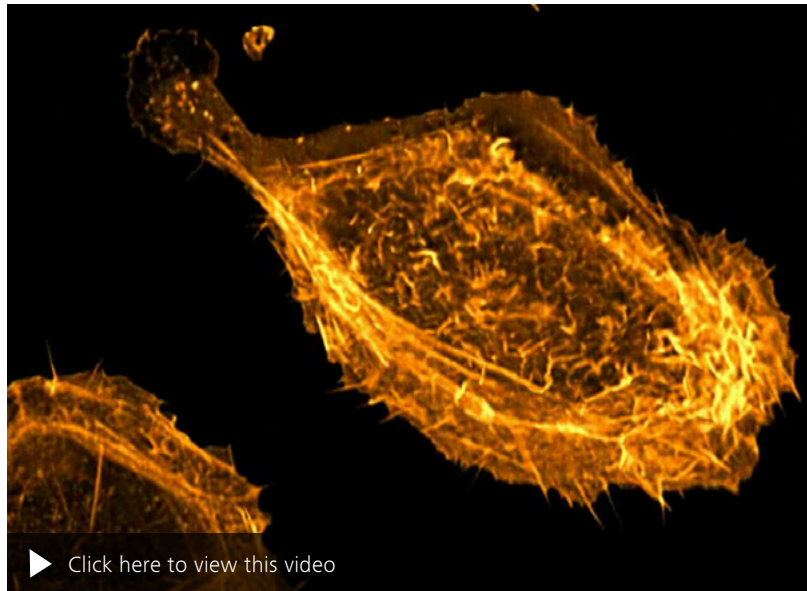

▶ [Click here to view this video](#)

*U2OS cell expressing Lifeact-tdTomato undergoing mitosis during continuous imaging. Maximum intensity projection. The cell was imaged constantly for 2.5 hours; one volume ( $113 \times 90 \times 11 \mu\text{m}^3$ ) every 2.2 secs. A total of 1,404,000 images was recorded; 351 volume planes for 4,000 time points.*

## Boost your experiments with novel auto-fluorescent proteins

COS-7 cells transfected with ER-targeted StayGold\* fluorescence protein. StayGold is a novel, extremely bright and photostable auto-fluorescent protein in the green range. The time series shows no signs of photobleaching or phototoxicity. After 40 min of continuous imaging, no loss of fluorescence intensity can be observed, and the integrity of the extremely photosensitive ER network is fully retained.

\* <https://www.nature.com/articles/s41587-022-01278-2>

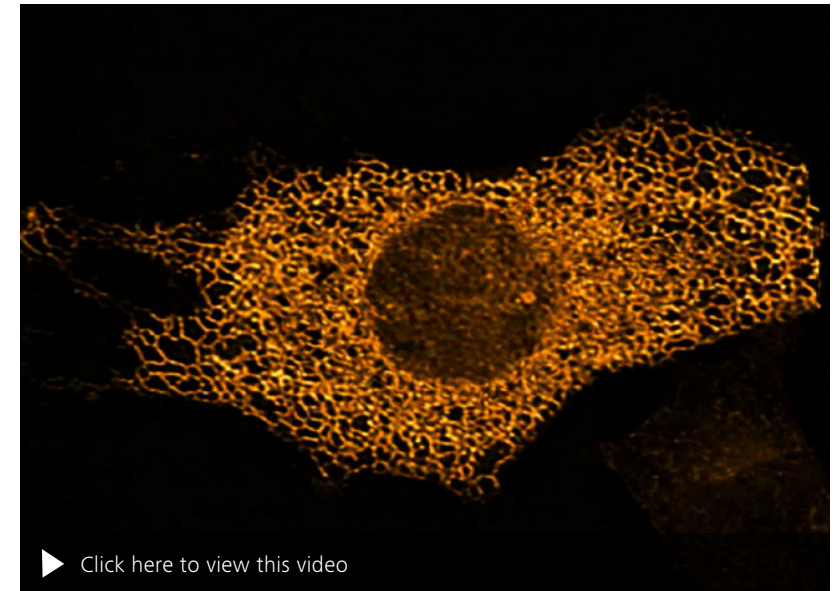

▶ [Click here to view this video](#)

*COS-7 cells transfected with ER-targeted StayGold fluorescence protein. Maximum intensity projection. Recorded with 1 ms exposure time for 40 min continuously. 802,000 images in total. One volume ( $105 \times 56 \times 14 \mu\text{m}^3$ ) per 1.1 seconds. Sample courtesy: A. Miyawaki, RIKEN Institute, Japan*

# ZEISS Lattice Lightsheet 7 at Work

- › In Brief
- › The Advantages
- › **The Applications**
- › The System
- › Technology and Details
- › Service

## Image developing life at early stages

Imaging of live oocytes is particularly challenging as this earliest stage in life is extremely delicate and sensitive to light. Lattice light sheet microscopy is the perfect tool to observe life at its earliest stage without disturbing the process.

## Mouse metaphase II oocyte

Live mouse oocytes arrested in metaphase II and stained for mitochondria (cyan), microtubules (magenta) and chromosomes (yellow).

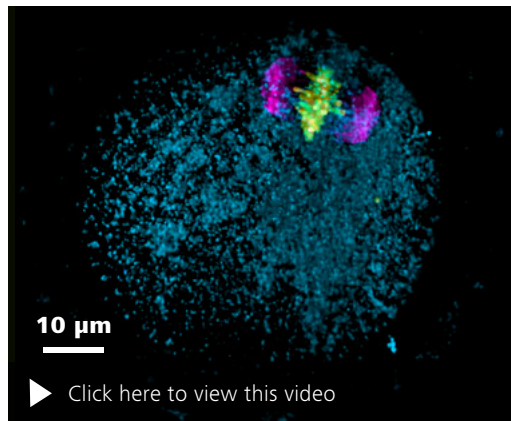

Sample courtesy of C. So, MPI Göttingen, Germany

## Mouse germinal vesicle oocytes

Fixed mouse germinal vesicle oocytes stained for the nuclear envelope (anti-lamin, cyan), actin (phalloidin, magenta), and microtubules (anti-tubulin, yellow). The 100 × 1,800 lattice light sheet was used for imaging of the whole oocyte.

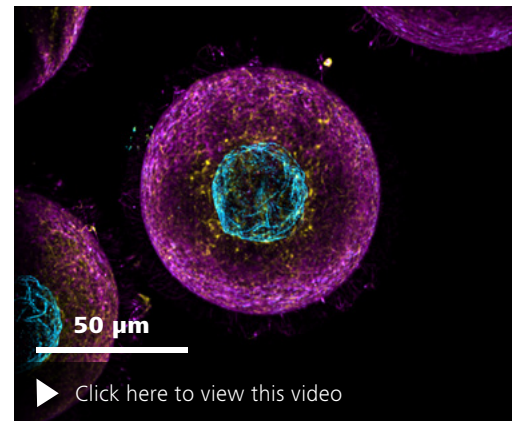

Sample courtesy of C. So, MPI Göttingen, Germany

## Mouse germinal vesicle oocyte

Fixed mouse germinal vesicle oocytes stained for the nuclear envelope (anti-lamin, cyan), actin (phalloidin, magenta), and microtubules (anti-tubulin, yellow). The 15 × 650 lattice light sheet was used for high-resolution imaging of microtubule and actin structures. Follow the 3D structure of the microtubules in the movie.

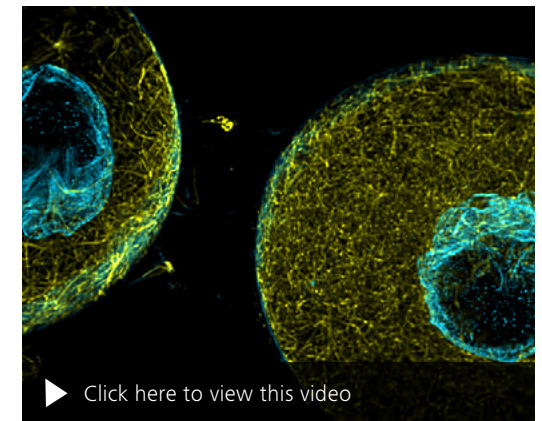

Sample courtesy of C. So, MPI Göttingen, Germany

# ZEISS Lattice Lightsheet 7 at Work

- › In Brief
- › The Advantages
- › **The Applications**
- › The System
- › Technology and Details
- › Service

## Image developing life of small evolving organisms

### Zebrafish embryo

DeltaD-YFP transgenic zebrafish embryo (Liao et al. 2016, Nature Communications). Fusion protein driven by a transgene containing the endogenous regulatory regions, expression in the tailbud and pre-somitic mesoderm. Signal visible in the cell cortex, and in puncta corresponding to trafficking vesicles (green); nuclei in magenta. The embryo was imaged for 5 minutes constantly; one volume ( $150 \times 50 \times 90 \mu\text{m}^3$ ) every 8 sec.

### Zebrafish embryo

High-speed movie of zebrafish embryo. Volumetric imaging of trafficking mRNA molecules (green). Nuclei are shown in magenta. Data is displayed as maximum intensity projection. One volume ( $86 \times 80 \times 12 \mu\text{m}^3$ ) was recorded every 2.5 sec.

### Zebrafish embryo

Trafficking mRNA molecules were tracked in arivis Vision4D®. The movement of the zebrafish embryo was first corrected using a nucleus reference track. Then individual mRNA molecules were tracked over time to result statistics such as speed and directionality.

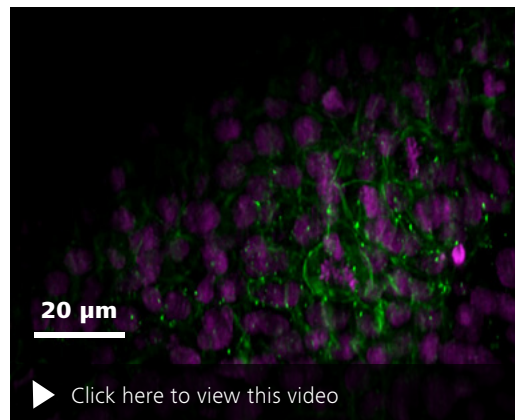

Sample courtesy of Prof. A. Oates, EPFL, Switzerland

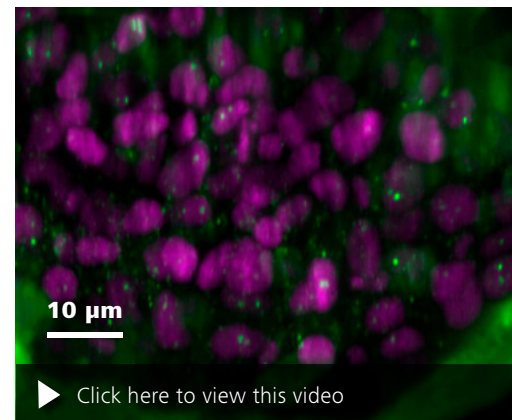

Sample courtesy of Prof. A. Oates, EPFL, Switzerland

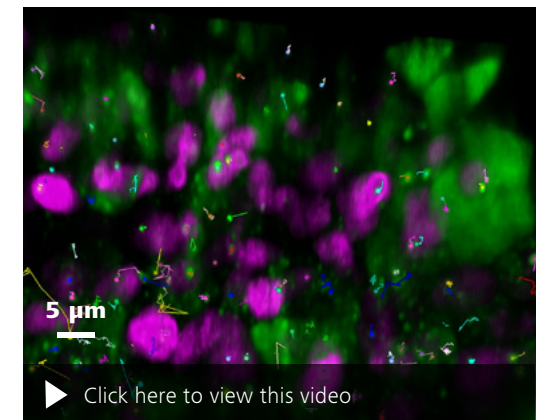

Sample courtesy of Prof. A. Oates, EPFL, Switzerland

# ZEISS Lattice Lightsheet 7 at Work

- › In Brief
- › The Advantages
- › **The Applications**
- › The System
- › Technology and Details
- › Service

## Image developing life of small evolving organisms

### C. elegans embryo

C. elegans embryo stained for nuclei. The movie shows a color-coded depth projection of the embryo. The embryo was imaged for 10+ minutes constantly; one volume every 700 msec.

Imaged volume:  $115 \times 50 \times 30 \mu\text{m}^3$ . A total of 101,000 images was recorded; 101 volume planes for 1,000 time points.

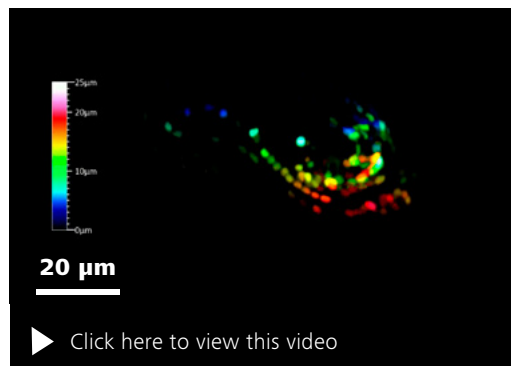

Customer sample

### C. elegans embryo

C. elegans embryo stained for nuclei. The movie shows a color-coded depth projection of the embryo. The embryo was imaged for 19+ hrs every 5 mins and can be observed going through its normal sleep-wake cycle.

Imaged volume:  $115 \times 50 \times 30 \mu\text{m}^3$ . A total of 23,836 images was recorded; 101 volume planes for 236 time points.

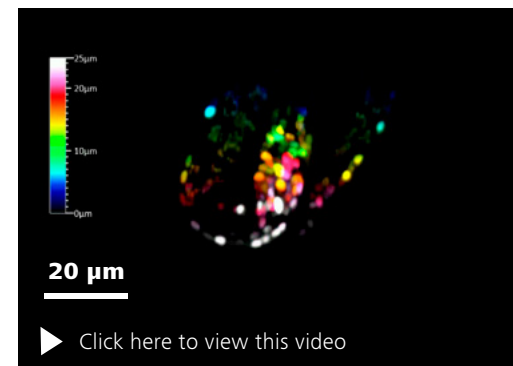

Customer sample

### C. elegans embryo

C. elegans embryo at the late bean stage (~400 min post fertilization) with ~560 nuclei marked with HIS-58::mCherry (magenta) and centrioles marked by GFP::SAS-7 (green).

Cells in mitosis show condensed signal of HIS-58::mCherry and centrioles at spindle poles.



Sample courtesy of N. Kalbfuss, Göncü Lab, EPFL, Switzerland

# ZEISS Lattice Lightsheet 7 at Work

- › In Brief
- › The Advantages
- › **The Applications**
- › The System
- › Technology and Details
- › Service

## Image developing life of small evolving organisms

### Drosophila embryo

*Drosophila melanogaster* is a model organisms in many research fields such as biomedical research. Many genetically modified variants are available to researchers. This video shows a drosophila embryo with GFP labeling as it moves over time. A total of 91,100 images were taken, 911 volume planes, 100 time points. One volume, every 15 secs; imaging duration 25 mins, imaging volume:  $300 \times 455 \times 145 \mu\text{m}^3$ .



*Maximum intensity projection of a Drosophila embryo with GFP labeling.*

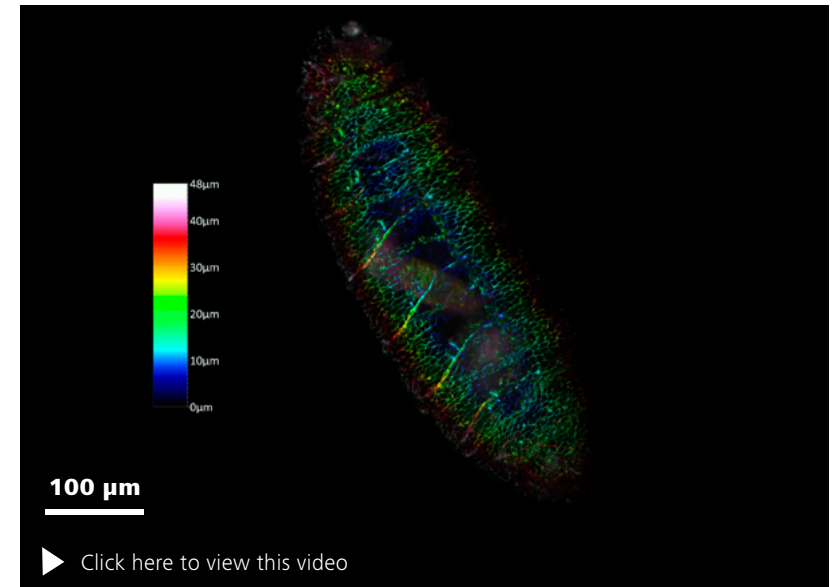

*Color-coded depth projection of a Drosophila embryo with GFP labeling.*

# ZEISS Lattice Lightsheet 7 at Work

- › In Brief
- › The Advantages
- › **The Applications**
- › The System
- › Technology and Details
- › Service

## Image developing 3D cell models

Spheroids and organoids are in-vitro models of organs – much smaller and simpler but easy to produce and thus for developmental biologists an invaluable tool to study organ development. Unlike cell cultures which usually consist of a monolayer of cells only, cells in spheroids / organoids form three-dimensional structures, allowing for the investigation of cell migration and differentiation inside 3D cell models. With lattice light-sheet microscopy, imaging the development and self-organization of organoids becomes reality.

3D rendering of a spheroid consisting of cells expressing H2B-mCherry (cyan) and  $\alpha$ -Tubulin-mEGFP (magenta). Not every cell is labelled.

Spheroid of U2OS cells expressing td-Tomato (green) stained with a cell marker dye (white) for visualization of the whole spheroid. The spheroid is  $\sim 200 \mu\text{m}$  in diameter and was imaged using the  $100 \times 1800$  lattice light-sheet. The spheroid was imaged to a depth of  $100 \mu\text{m}$  by recording multiple volume scans on top of each other.

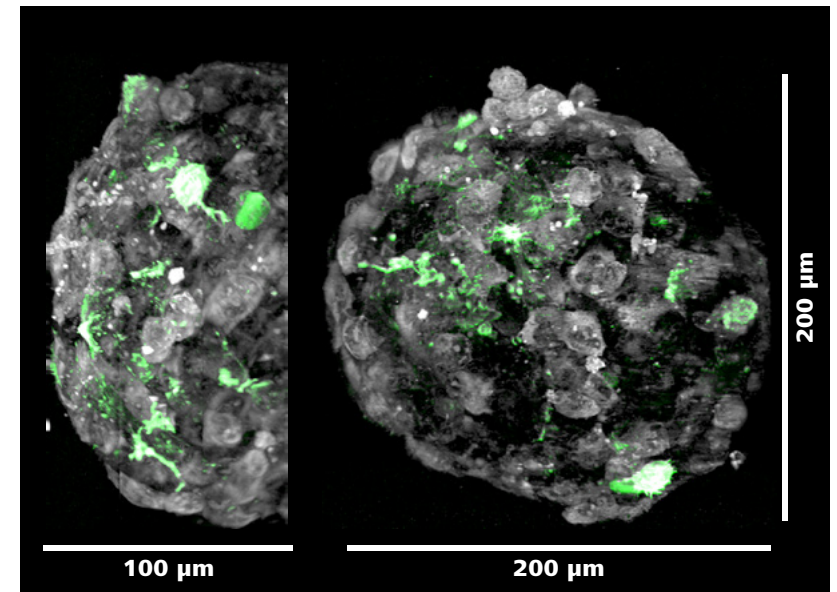

# ZEISS Lattice Lightsheet 7 at Work

- › In Brief
- › The Advantages
- › **The Applications**
- › The System
- › Technology and Details
- › Service

## Imaging developing plants and plant seeds

### Pollen Grain

Pollen tube stained for mitochondria (MitoTracker Green, green) and lysosomes (Lysotracker Red, red). Watch the pollen tube extend from the crack in the pollen grain (visualized by its autofluorescence).

Mitochondria don't quite advance to the very tip of the pollen tube but stop a few microns before the tip. Rendering of the data set was performed in arivis Vision4D®.

### Pollen Tube

Watch mitochondrial dynamics inside the pollen tube. Mitochondria move towards the tip at the edges and back in the middle of the tube.

While trafficking, mitochondria constantly fuse and divide for repair processes and to share and distribute biological molecules.

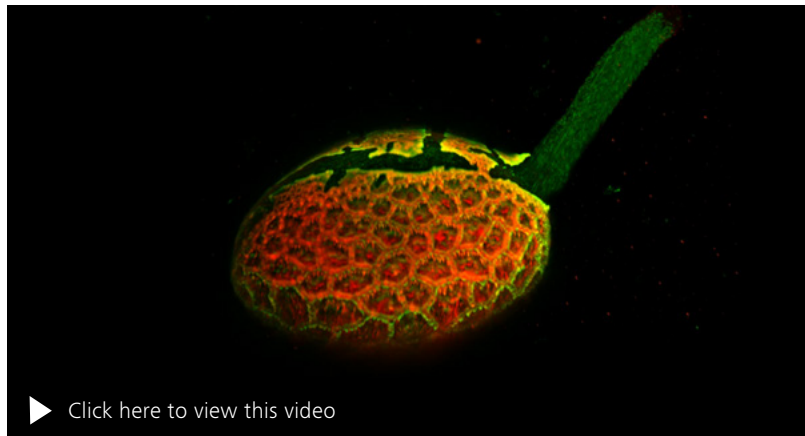

Sample courtesy of R. Whan, UNSW, Sydney, Australia

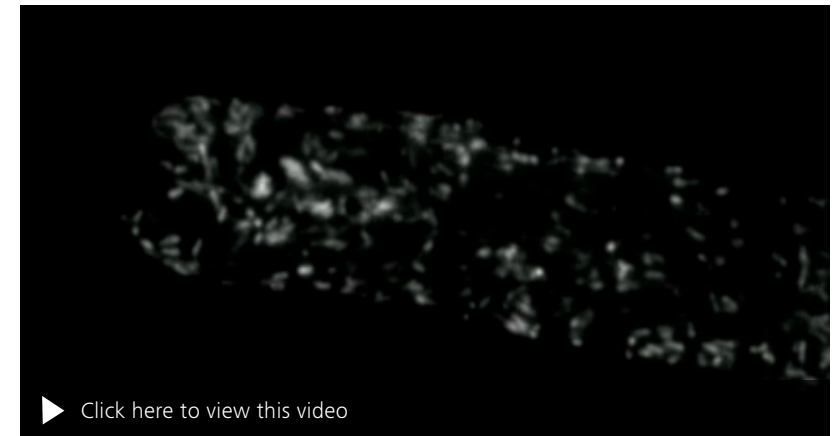

Sample courtesy of R. Whan, UNSW, Sydney, Australia



# Your Flexible Choice of Components

- › In Brief
- › The Advantages
- › The Applications
- › **The System**
- › Technology and Details
- › Service

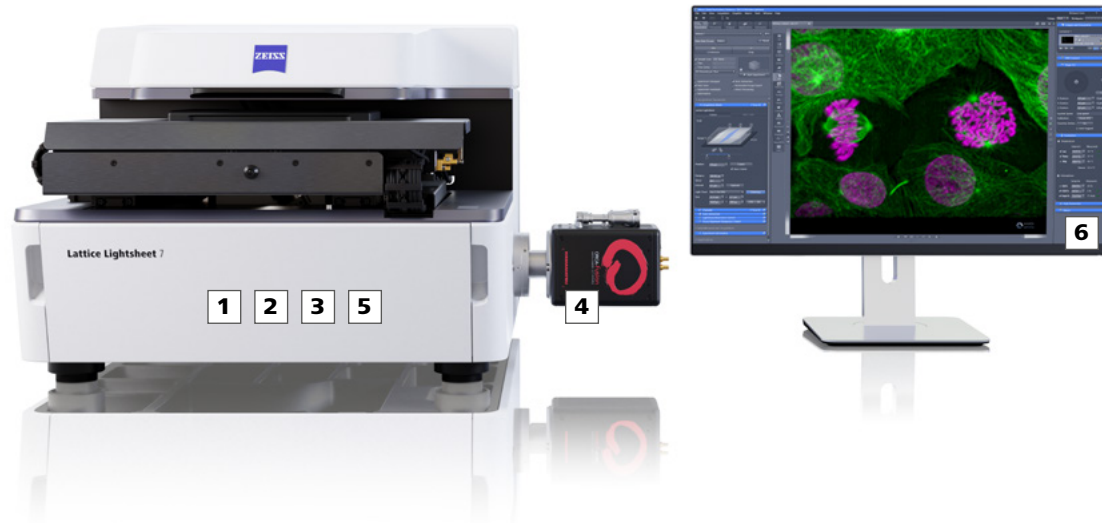

## 1 Microscope

- Lattice Lightsheet 7

## 2 Objectives

- Illumination: 13.3× / NA 0.4
- Detection: 44.83× / NA 1.0

## 3 Illumination

- LED (white & red) for transmitted light
- Laser (488 nm, 561 nm, 640 nm) for reflected light and epi-fluorescence

## 4 Cameras

- Hamamatsu ORCA-Fusion  
(1 or 2 camera system)

## 5 Filters

### Emission Filter Camera 1

- BP 570-620 + LP 655
- BP 495-550 + LP 655
- LBF 405/488/561/642
- ND filter
- Empty
- BP 495-570
- LP 570

### Emission Filter Camera 2

- BP 570-610 IR+
- Empty
- BP 495-550 + BP 570-620
- BP 500-550 IR+

## Secondary Beam Splitter

- Plate
- LP 565
- LP 640
- Empty

## 6 Software

- ZEN 3.6 (blue edition)
- Lattice Lightsheet Processing Module

# ZEISS Lattice Lightsheet 7: System Overview

- › In Brief
- › The Advantages
- › The Applications
- › **The System**
- › Technology and Details
- › Service

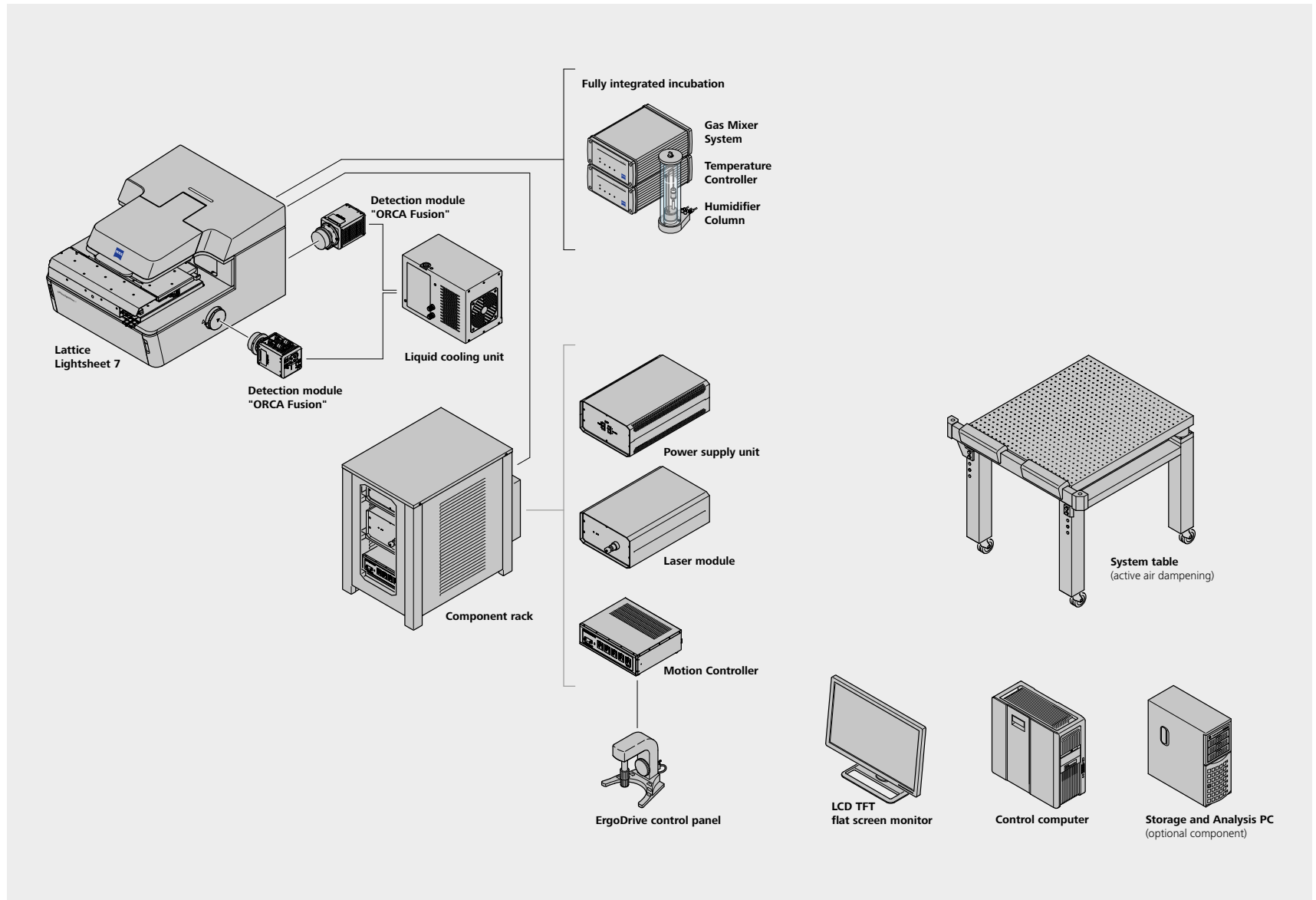

# Technical Specifications

- › In Brief
- › The Advantages
- › The Applications
- › The System
- › **Technology and Details**
- › Service

Component	Description
<b>Core Optics</b>	<p>Illumination objective lens 13.3× / 0.4 (at 30° angle to cover glass) with static phase element</p> <p>Detection objective lens 44.83× / 1.0 (at 60° angle to cover glass) with Alvarez manipulator</p> <p>Meniscus lens; relay of core optics to cover slip of sample carrier</p> <p>Autoimmersion: water, motorized dispenser</p>
<b>Illumination</b>	<p>Transmitted light: LED (white centered and side, red centered illumination) with oblique contrast for sample positioning and overview; no Köhler illumination, not specified for high quality imaging</p> <p>Reflected light and epifluorescence: laser (488 nm, 561 nm, 640 nm) for beam adjustment and fluorescence imaging</p>
<b>Detection Modules</b>	<p>Hamamatsu ORCA-Fusion sCMOS camera; requires liquid cooling; up to two camera ports (right side port: camera 1, rear port: camera 2)</p> <p>Pixel size: 6.5 μm; Max. pixel format: 2,048 × 2,048 (4.2 Megapixel); Bit depth: 16 bit; QE: up to 80%</p>
<b>Image Acquisition Speed</b>	<p>Volume: 3 Vol/s @ 300 μm × 50 μm × 20 μm</p> <p>Plane: 400 frames/s @ 300 μm × 20 μm</p> <p>Up to 3 colors fast sequential (framewise or stackwise switch)</p>
<b>Light Sheets</b>	<p>Beam shaping by cylinder lens and spatial light modulator (SLM)</p> <p>Pre-defined Sinc3 beams with length [μm] × thickness [nm]:</p> <ul style="list-style-type: none"> <li>■ 15 × 550 (w/side lobes) &amp; 15 × 650 (w/o side lobes)</li> <li>■ 30 × 700 (w/side lobes) &amp; 30 × 1,000 (w/o side lobes)</li> <li>■ 100 × 1,400 (w/side lobes) &amp; 100 × 1,800 (w/o side lobes)</li> </ul>
<b>Immersion and Incubation Media</b>	<p>Sample carriers and optics designed for aqueous media (<math>n_g = 1.33</math>)</p>
<b>Sample Mounting</b>	<p>Standard glass bottom cell culture dishes and multi-well plates (glass 1.5; 0.15 mm – 0.19 mm); skirt &lt;0.5 mm</p>
<b>Sample Carrier Frames</b>	<ul style="list-style-type: none"> <li>■ Sample carrier frame Dish 35: for 35 mm cell culture dishes</li> <li>■ Sample carrier frame Dish 35...40: for 35–40 mm cell culture dishes</li> <li>■ Sample carrier frame Slide: for slides 26 mm × 76 mm; also suitable for multi-well glass-bottom slides 26 mm × 76 mm</li> <li>■ Sample carrier frame Chamber slide: for LabTekR chambers 25 mm × 57 mm; also suitable for multi-well glass-bottom slides 25 mm × 57 mm</li> <li>■ Sample carrier frame Multiwell: for multiwell microplates 85.48 mm × 127.76 mm</li> </ul>
<b>Resolution (xyz)</b>	<p>Light sheet selection (from 6 pre-defined sheets)</p> <p>Deskewed: 330 nm × 330 nm × 500–1000 nm;</p> <p>Deskewed w/DCV: 290 nm × 290 nm × 450 nm–900 nm (z-res. = light sheet thickness if ≤1000 nm)</p>
<b>Voxel size (xyz)</b>	<ul style="list-style-type: none"> <li>■ Skewed image: 145 nm × step size × 145 nm</li> <li>■ Deskewed image: 145 nm × step size/2 × 145 nm</li> <li>■ Glass cover transformed image: 145 nm × 145 nm × 145 nm</li> <li>■ Step-size for Nyquist sampling: 200 nm</li> </ul>
<b>Penetration Depth</b>	<p>Up to 200 μm</p>
<b>Field of View (FOV)</b>	<p>x: 300 μm; y: defined by scan range</p>
<b>Spectral Range of Detection</b>	<p>490 nm – 740 nm</p>

# Technical Specifications

- › In Brief
- › The Advantages
- › The Applications
- › The System
- › **Technology and Details**
- › Service

Component	Description						
<b>Filters</b>	<table border="0" style="width: 100%;"> <tr> <td style="width: 33%;">Emission Filter Camera 1</td> <td style="width: 33%;">Emission Filter Camera 2</td> <td style="width: 33%;">Secondary Beam Splitter</td> </tr> <tr> <td> <ul style="list-style-type: none"> <li>■ BP 570-620 + LP 655</li> <li>■ BP 495-550 + LP 655</li> <li>■ LBF 405/488/561/642</li> <li>■ ND filter</li> <li>■ Empty</li> <li>■ BP 495-570</li> <li>■ LP 570</li> </ul> </td> <td> <ul style="list-style-type: none"> <li>■ BP 570-610 IR+</li> <li>■ Empty</li> <li>■ BP 495-550 + BP 570-620</li> <li>■ BP 500-550 IR+</li> </ul> </td> <td> <ul style="list-style-type: none"> <li>■ Plate</li> <li>■ LP 565</li> <li>■ LP 640</li> <li>■ Empty</li> </ul> </td> </tr> </table>	Emission Filter Camera 1	Emission Filter Camera 2	Secondary Beam Splitter	<ul style="list-style-type: none"> <li>■ BP 570-620 + LP 655</li> <li>■ BP 495-550 + LP 655</li> <li>■ LBF 405/488/561/642</li> <li>■ ND filter</li> <li>■ Empty</li> <li>■ BP 495-570</li> <li>■ LP 570</li> </ul>	<ul style="list-style-type: none"> <li>■ BP 570-610 IR+</li> <li>■ Empty</li> <li>■ BP 495-550 + BP 570-620</li> <li>■ BP 500-550 IR+</li> </ul>	<ul style="list-style-type: none"> <li>■ Plate</li> <li>■ LP 565</li> <li>■ LP 640</li> <li>■ Empty</li> </ul>
Emission Filter Camera 1	Emission Filter Camera 2	Secondary Beam Splitter					
<ul style="list-style-type: none"> <li>■ BP 570-620 + LP 655</li> <li>■ BP 495-550 + LP 655</li> <li>■ LBF 405/488/561/642</li> <li>■ ND filter</li> <li>■ Empty</li> <li>■ BP 495-570</li> <li>■ LP 570</li> </ul>	<ul style="list-style-type: none"> <li>■ BP 570-610 IR+</li> <li>■ Empty</li> <li>■ BP 495-550 + BP 570-620</li> <li>■ BP 500-550 IR+</li> </ul>	<ul style="list-style-type: none"> <li>■ Plate</li> <li>■ LP 565</li> <li>■ LP 640</li> <li>■ Empty</li> </ul>					
<b>System PC / Workstation</b>	<p>HP Z6 G4 Rev2 workstation            Chipset: Intel C622            Memory: max. 192 GB RAM            SSD: 1x 512 GB M.2 NVMe (for pagefile and operating system); 1x MTE662T2 M.2 PCIe NVMe 2 TB            Hard Drives: 2x 6 TB SATA 7,200 rpm (configured as 6 TB RAID 10 hard drive); increase capacity from 6 TB (RAID 10) to 12 TB (RAID 10)            Processor: Intel® Xeon® Gold 6234 (3.2 GHz, 24.75 MB cache, 8 cores)            Graphics Card: NVIDIA Quadro RTX6000 24 GB DB            Network Adapter: 2x 10 GbE RJ45 (hp Z6); additional network adapter 2x 10 GbE RJ45 (hp Z6) e.g. for connection of storage systems            Operating system: Windows 10 IoT Enterprise 2019 LTSC Embedded x64</p>						
<b>Storage and Data Analysis PC</b>	<p>CPU: Intel P XEON E5-2620V3 2,4 GHz LGA2011 L3 25 MB Box            Graphics Card: NVIDIA Quadro RTX6000 24 GB DP            Memory: 64 GB (4x 16 GB) included, max. 256 GB RAM;            Memory slots: 16x DIMM slots            Hard Drives: 6x HDD 12 TB, RAID 5 configured to 55 TB data storage volume; 2x Solid State Drive 240 GB for pagefile and operating system            10 Gbit Ethernet on motherboard and 10 GbE cable to connect with PC for system control (high speed data streaming)            Network Adapter: LAN: 2x 10 GbE            5x USB 3.0, 4x USB 2.0 ports            Operating system: Windows 10 IoT Enterprise 2019 LTSC</p>						
<b>Monitor</b>	<p>TFT 27" HP Z27n G2 (68 cm)            TFT 32" HP Dream color Z32x (80 cm)            TFT 37.5" HP Z38c (95 cm)</p>						
<b>Trigger</b>	<p>Trigger-out signal via BNC connector. High level of 3.3 V (nominal value of the high level: &gt; 3.2 V &lt; 4.0 V and nominal value of the low level: 0 V ±0.4 V).            The minimal working resistance is 5 kΩ.</p>						
<b>Data Acquisition Rate</b>	<p>With dedicated Lattice Lightsheet 7 storage module up to 800 Mbit/s</p>						
<b>Software Processing</b>	<p>Lattice Lightsheet 7 Processing (Subset, Deconvolution, Deskew, Deskew + Cover glass Transformation)            3DxL, 3DxL Plus (optional), arivis Vision4D® (optional)            Direct and Batch Processing</p>						
<b>Software Acquisition</b>	<p>Multidimensional imaging (time, positions, tiles); combination of multidimensions possible            Light sheet selection (from 6 pre-defined sheets)            Autoimmersion            Environmental control (temperature, CO<sub>2</sub> and humidity; O<sub>2</sub> via N<sub>2</sub> optional)</p>						

# Technical Specifications

- › In Brief
- › The Advantages
- › The Applications
- › The System
- › **Technology and Details**
- › Service

<b>Microscope</b>	Standalone box system, sealed, turnkey, laser safe, no eyepieces, inverted		
<b>Physical Dimensions</b>	<b>Approx. Width × Depth × Height</b>	<b>Approx. Weight</b>	
Main System Module Lightsheet 7	600 mm × 425 mm × 380 mm	48 kg	
Component Rack (houses Laser module, Power supply unit & Stage Motion Controller)	550 mm × 740 mm × 600 mm	56 kg	
System Table for main System Module Lattice Lightsheet 7, Level regulated	900 mm × 750 mm × 830 mm	130 kg	
<b>Incubation</b>			
<b>Heating System</b>	Heating of sample chamber (no cooling) T: ambient to 42 °C ± 0.1 °C; up to 1.5 °C/min heating, up to 1.0 °C/min cooling		
<b>Gas Mixer System</b>	Requires compressed air, CO <sub>2</sub> (and N <sub>2</sub> ) supply; adjustable concentration	CO <sub>2</sub> : 0% to 15% ±0.35% O <sub>2</sub> : 1% to 21% ±0.20% Humidity: 20% – 99% ±2.50%	
<b>Stage</b>	Five-axis multi-coordinate stage with Piezo motors	Specifications: x / y / z / Tilt (R <sub>xz</sub> /R <sub>yz</sub> ) (after homing)	
<b>Travel Range</b>	72 mm / 108 mm / 1.5 mm / ±5°		
<b>Reproducibility</b>	1 μm / 1 μm / 0.5 μm / 3 minutes of arc		
<b>Smallest Increment</b>	200 nm / 200 nm / 200 nm / 3 minutes of arc		
<b>Laser Module</b>			
<b>Laser Class</b>	All Lasers are class 3B The installed system as a whole is laser class 2		
<b>Laser Wavelengths, Type and Power (Power: pre-Fiber)</b>	Laser line	Type	Power output (in pupil)
	488 nm	diode	10 mW (2 mW)
	561 nm	diode (SHG)	10 mW (2 mW)
	640 nm	diode	5 mW (1 mW)



# Technical Specifications

- › In Brief
- › The Advantages
- › The Applications
- › The System
- › **Technology and Details**
- › Service

Environmental Conditions			
Operation	Permissible ambient temperature (specified performance)	22 °C ± 1 °C	
	Permissible ambient temperature (reduced performance)	15 °C to 30 °C	
	Permissible relative air humidity (no condensation)	< 65 % at 30 °C	
	Max. altitude of installation site	Max. 2,000 m	
Warm-up Time	60 min	For high precision and/or long-term measurements ≥ 3 h	
Vibrations	To be operated in conformance with Vibration Class C. VC-C, 12,5 µm/s RMS amplitude of frequency band 8 – 80 Hz (RMS = root mean square) according to ISO 10811.		
Electrics and Power			
Mains Voltage		220 V AC to 240 V AC (±10 %)	100 V AC to 125 V AC (±10 %)
Supply Frequency		50 to 60 Hz	50 to 60 Hz
Lattice Lightsheet 7 System	Max. current	Single 4.5 A phase	Single 9 A phase
	Power consumption	800 VA max.	800 VA max.
Data Analysis PC	Power consumption	400 VA max.	400 VA max.
Protection Class / Protection Type		I / IP 20	
Overvoltage Category		II	
EMC Inspection		According to DIN EN 61326-1 (10/2006)	
Emitted Interference		According to CISPR 11/DIN EN 55011 (05/2010)	
Heat Loss			
System Lattice Lightsheet 7 (incl. Lasers and Accessories)	700 W		
Data Analysis PC	350 W		
Patents which apply for Lattice Lightsheet 7	US6037583, US6392796, US7554725, US7787179, US8214561, EP1576404		

# ZEISS Service – Your Partner at All Times

Your microscope system from ZEISS is one of your most important tools. For over 170 years, the ZEISS brand and our experience have stood for reliable equipment with a long life in the field of microscopy. You can count on superior service and support - before and after installation. Our skilled ZEISS service team makes sure that your microscope is always ready for use.

- › In Brief
- › The Advantages
- › The Applications
- › The System
- › Technology and Details
- › **Service**

## Procurement

- Lab Planning & Construction Site Management
- Site Inspection & Environmental Analysis
- GMP-Qualification IQ/OQ
- Installation & Handover
- IT Integration Support
- Startup Training

## Operation

- Predictive Service Remote Monitoring
- Inspection & Preventive Maintenance
- Software Maintenance Agreements
  - Operation & Application Training
  - Expert Phone & Remote Support
- Protect Service Agreements
  - Metrological Calibration
  - Instrument Relocation
    - Consumables
    - Repairs

## New Investment

- Decommissioning
- Trade In

## Retrofit

- Customized Engineering
- Upgrades & Modernization
- Customized Workflows via APEER



Please note: Availability of services depends on product line and location

>> [www.zeiss.com/microservice](http://www.zeiss.com/microservice)



**Carl Zeiss Microscopy GmbH**  
07745 Jena, Germany  
microscopy@zeiss.com  
www.zeiss.com/lattice-lightsheet