

# Combining scanning performance with application freedom



## **ZEISS Axioscan 7**

Your High-performance Slide Scanner for Fluorescence, Brightfield and Polarization



[www.zeiss.com/axioscan-bio](http://www.zeiss.com/axioscan-bio)

Seeing beyond

# Your High-performance Slide Scanner for Fluorescence, Brightfield and Polarization

- › In Brief
- › The Advantages
- › The Applications
- › The System
- › Technology and Details
- › Service

Digitize your specimens with Axioscan 7 – the reliable, reproducible way to create high-quality virtual microscope slides. Axioscan 7 combines qualities that you would not expect to get in a slide scanner: high speed digitization and outstanding image quality plus an unrivaled variety of imaging modes are all available in a fully automated and easy to operate system.

The most challenging research tasks as well as your routine scanning applications are supported by powerful hardware and perfectly featured software. Capture virtual slides quickly with high-speed scanning, while retaining consistently high quality, whether you want to capture brightfield, fluorescence or polarized light images.

Axioscan 7 is controlled by ZEN Slidescan, which allows you to efficiently create and apply scan profiles, even in complex fluorescence experiments. A wealth of ZEN image analysis tools processes your data accurately afterward.

Access your virtual slides anytime, no matter where you are or what operating system you are using. Share your images online with colleagues and organize entire projects, even when you're on the go.



# Simpler. More Intelligent. More Integrated.

- › In Brief
- › **The Advantages**
- › The Applications
- › The System
- › Technology and Details
- › Service

## Robust scan performance

From an automated system, you expect absolute reliability for continuous operation. ZEISS Axioscan 7 repeatedly produces digitized slides at dramatically improved speed, thanks to hardware components designed for extended, uninterrupted operation. A fully motorized condenser, powerful light sources and sensitive cameras ensure 24/7 scan performance, whether you have many similar slides or mixed applications to process. Equal attention has been paid to both software performance and ease of use. Easily assigned scan profiles allow acquisition runs to be set up quickly. The ability to manually edit focus points provides additional flexibility. Axioscan 7 software is built to flawlessly process large amounts of raw data — in the range of several terabytes.



Scan up to 100 slides, which can have different scan profiles and imaging modes assigned, in one pass.

## Automated application flexibility

ZEISS Axioscan 7 allows rapid switching among fluorescence, brightfield and polarization scanning modes, with the highest quality fast and gentle imaging fully available to you in each of these modes. Benefit from contrast flexibility and high scan speed when digitizing HE-stained tissue samples or other brightfield applications. Fast filter wheels and a spectral range up to far red excitation light expand your fluorescence imaging capabilities — in combination with the new sample-preserving contrast method Transfer of Intensity Equation (TIE), multiplex imaging reaches a new level of performance. The combination of all imaging modes let you extract maximum sample information with a minimum of effort.

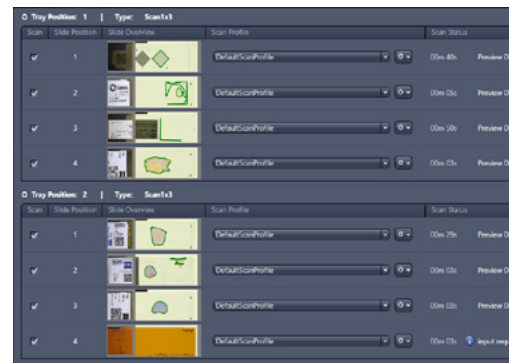

Choose from fluorescence, brightfield, or polarization options according to the needs of your applications. Combine different imaging modes to extract more information from your samples.

## The bigger picture: slide scanning within the ZEN environment

ZEN Slidescan is optimized not only for the automated generation of virtual slides but also for integration within the powerful ZEN imaging software universe, which provides access to numerous additional processing and analysis functions. ZEN Connect, the ZEISS software for correlative microscopy, enables more advanced workflows — from automated slide scanning to detailed studies on other ZEISS microscope systems. The established CZI data format opens the possibility to use additional third-party data analysis tools. With ZEN Data Storage and ZEN Data Explorer, you can access and share your scanned data from anywhere, at any time.

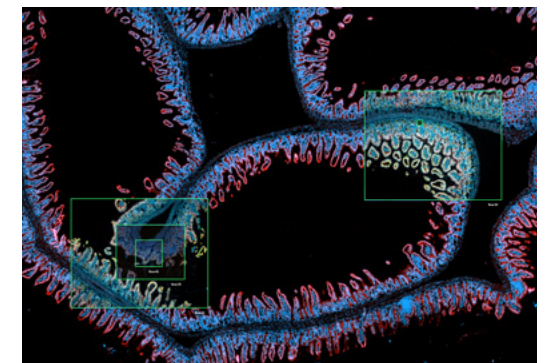

Automated slide scanning and detailed studies on other ZEISS microscope systems combined in a ZEN Connect project

# Your Insight into the Technology Behind It

- › In Brief
- › **The Advantages**
- › The Applications
- › The System
- › Technology and Details
- › Service

With ZEISS Axioscan 7, you digitize large numbers of specimens in a reliable, reproducible, and hassle-free way.

## Fast automated scanning

State-of-the-art hardware – including strong light sources, a motorized condenser, fast filter wheels, filter sets designed for advanced multiplexing applications, and modern cameras from the ZEISS Axiocam portfolio – all work in perfect union with software that offers a clear scan profile concept and easy-to-use wizards for fast job setup. Many additional options allow for advanced modification to create sophisticated slide scanning workflows. Once created, scan profiles are easily selected and assigned so you may run your experiments with high degrees of both automation and application flexibility.

## High throughput

Digitize a large number of slides, even with diverse scan profiles, in a single run. Axioscan 7 supports unattended scans of up to 100 slides in the standard 26 mm × 76 mm format for the entire job run. Monitor scanning progress by observing the status LEDs for each individual sample tray at the front of the system or by accessing the system remotely.

## Reproducible quality

Axioscan 7 can be calibrated automatically so your virtual slides will be reproduced precisely and consistently between systems and over time. Get even better reliability by adding ZEISS Predictive Service: expert service technicians remotely diagnose all components so that preventive maintenance can be scheduled for maximum system uptime.



▶ [Click here to view this video](#)

# Your Insight into the Technology Behind It

- › In Brief
- › **The Advantages**
- › The Applications
- › The System
- › Technology and Details
- › Service

## Highly productive fluorescence imaging

Speed, gentle treatment and the optimal wavelength are critical when it comes to multispectral fluorescence imaging. Axioscan 7 employs swift and reproducible LED illumination, fast filter wheels, and a sophisticated filter concept to efficiently separate a broad range of fluorescence channels.

## Brilliant illumination

Choose between Colibri 7, the super-fast 7 wavelengths LED light source from ZEISS, or the white light LED light source X-Cite Xylis. Automatic calibration guarantees Colibri 7 operates with reproducible output power levels for each wavelength and therefore produces consistent quantitative data for all important dyes, fluorescent proteins and probes. Individual LEDs and integrated excitation filters make an additional filter wheel unnecessary and allow switching times of a few milliseconds between the color channels.



*The use of X-Cite Xylis together with a fast excitation filter wheel enables long wavelength sample illumination up to 770 nm. In addition, the green gap – typically a problem with LED fluorescent light sources – is overcome and comparable to classic arc lamps in this spectral range.*

## Advanced filter concept for application flexibility

The Axioscan 7 filter concept allows the shortest possible exposure times, maximum specimen protection and unparalleled information density without compromising data quality. Three synchronized high-speed filter wheels for excitation, beam splitting and emission enable fast switching between fluorescence channels. By using standard filter cubes in a 10-position filter turret, you can capture up to 9 fluorescence channels or even perform polarization light microscopy. When using Colibri 7, you can choose between single-band filters for perfect spectral separation or multi-band filters for instant channel switching without moving any hardware. Newly designed filter sets for multiplexing applications allow for clear spectral delineation without the need for additional software to separate fluorescent channels.

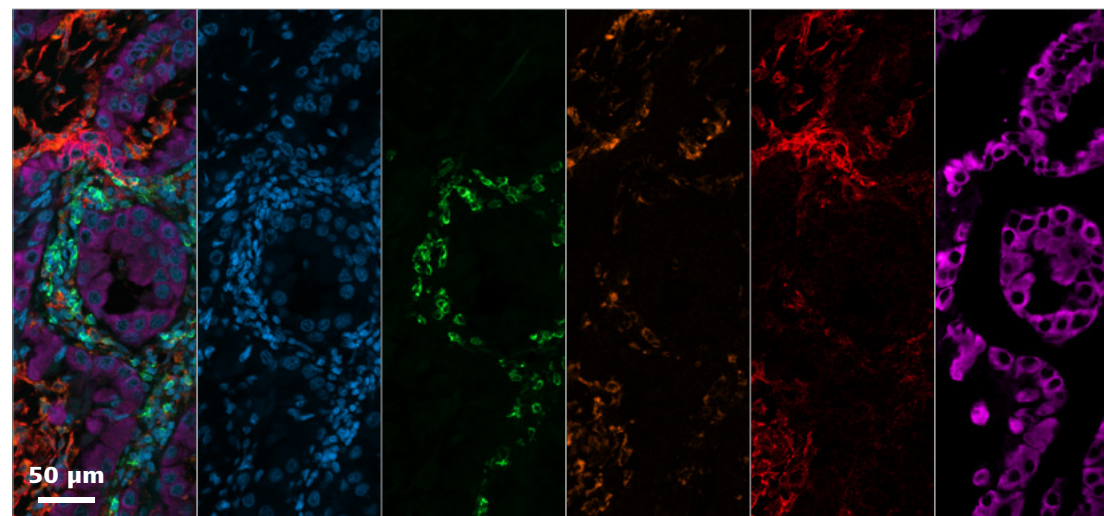

*Non-small cell lung cancer (NSCLC) tissue stained with UltiMapper I/O PD-L1 kit. Nuclear counterstain (blue), CD8 (green), CD68 (orange), PD-L1 (red), panCytoKeratin (magenta). Sample courtesy of Ultivue, Inc. Cambridge, Massachusetts, USA*

# Your Insight into the Technology Behind It

- › In Brief
- › **The Advantages**
- › The Applications
- › The System
- › Technology and Details
- › Service

## A variety of super-fast brightfield imaging modes

The newly designed condenser with its motorized modulator disk allows automatic switching between different brightfield imaging modes to adapt to the different requirements of your applications, while maintaining optimal scanning performance. The motorized aperture adapts to any selected objective and enables the new TIE contrast. Circular and linear polarization are now fully supported, opening a new range of experiments and modality combinations.

Axioscan 7 comes with a white light LED light source that is now 4 times stronger than its predecessor. This allows the microscope stage and objective revolver to move continuously while the LED flashes in sync with the camera, freezing movement effects in time by the flash strobe. You benefit from dramatically improved scan speeds when using standard brightfield imaging, TIE contrast, or the new polarization modes.

## Perfect color rendition

With its large chip and small pixel size, the new ZEISS Axiocam 705 color camera perfectly complements this setup to capture brilliant images in the many supported imaging modes.



The Axioscan 7 brightfield imaging performance is driven by a motorized condenser and a powerful white light source:

- 1) Motorized modulator disc
- 2) Circular polarizer
- 3) Motorized linear polarizer
- 4) Motorized aperture diaphragm
- 5) White light LED light source

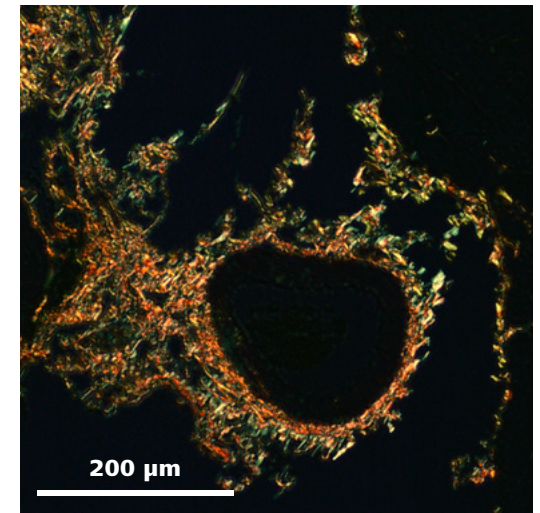
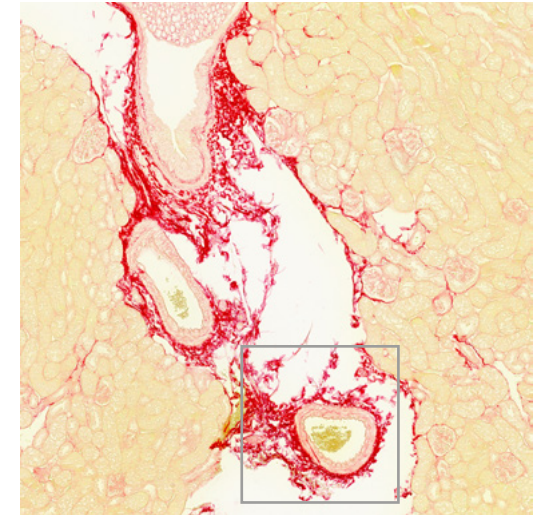

Mouse kidney wound healing assay, stained with sirius red; brightfield (top) and cross linear polarization.

Sample courtesy: Alexander Lomow, Evotec, Germany

# Your Insight into the Technology Behind It

- › In Brief
- › **The Advantages**
- › The Applications
- › The System
- › Technology and Details
- › Service

## Advanced cameras for perfect image quality

Cameras are crucial components for any automatic imaging system. Axioscan 7 is equipped with the most advanced Peltier-cooled cameras from the ZEISS Axiocam portfolio to support your brightfield and fluorescence applications with state-of-the-art imaging performance.

### Color camera Axiocam 705 color:

#### Large chip with perfect color rendition

We have implemented the latest color Axiocam, the 705 color CMOS camera. It offers 5-mega-pixel resolution with a 3.45  $\mu\text{m}$  pixel size and very low noise. With 55 frames per second acquisition speed in Axioscan 7 and a large field of view, Axiocam 705 rapidly accomplishes your brightfield and polarization imaging tasks.

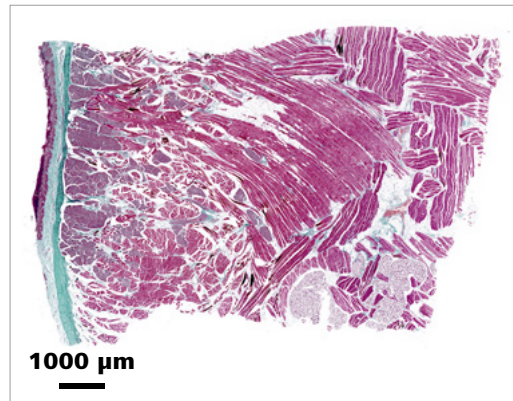

Mini pig tongue tissue section stained with masson trichrome.  
Sample courtesy: Alexander Lomow, Evotec, Germany

### Fluorescence camera Axiocam 712 mono:

#### Small pixels and high-speed imaging

Axiocam 712 mono is the perfect choice for your fluorescence imaging applications. It offers small pixels (3.45  $\mu\text{m}$ ), fully capturing the resolution potential of the high numerical aperture optics, and a very low readout noise. Use camera binning of 2x2 pixels for increased sensitivity. For the most demanding applications with weakest fluorescence signals, the Hamamatsu Orca Flash 4.0 is available as an option.

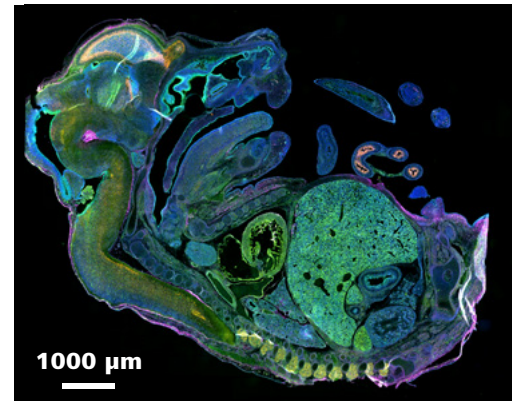

Mouse embryo sagittal cut, embryonic day E13, 12  $\mu\text{m}$ .  
SOX2 stained with Alexa488, Pax6 stained with Cy3, Nestin stained with Alexa647, Nuclei in Dapi.  
Sample courtesy: Ivan Mestres, TU Dresden, Germany



# Your Insight into the Technology Behind It

› In Brief

› **The Advantages**

› The Applications

› The System

› Technology and Details

› Service

## Improved detection. Better focusing. More context.

The new contrast method Transfer of Intensity Equation (TIE contrast) is one of the key advancements in the Axioscan 7.

Using this digital method for contrast generation in transparent samples, you record the interaction of a narrow cone of light with your sample's structures in three images: one in focus, and two out of focus above and below the focal plane.

From these three images, the phase information for the central plane is automatically extracted. Continuous acquisition in the z dimension, in combination with flash illumination and GPU-based fast image processing, enables very fast delivery of the final contrast images. You can choose to present this as either phase contrast or DIC-like relief contrast.

TIE contrast is an excellent tool to aid your experiments when working with sensitive fluorescent dyes:

- Detect transparent tissues with little to no contrast in regular brightfield mode.
- Speed the subsequent fluorescence imaging process with very fast flash-based focusing.
- Protect your sensitive dyes from bleaching during focusing by using the lowest light doses.
- Bring your fluorescent labels into context easily by applying the additional contrast information.

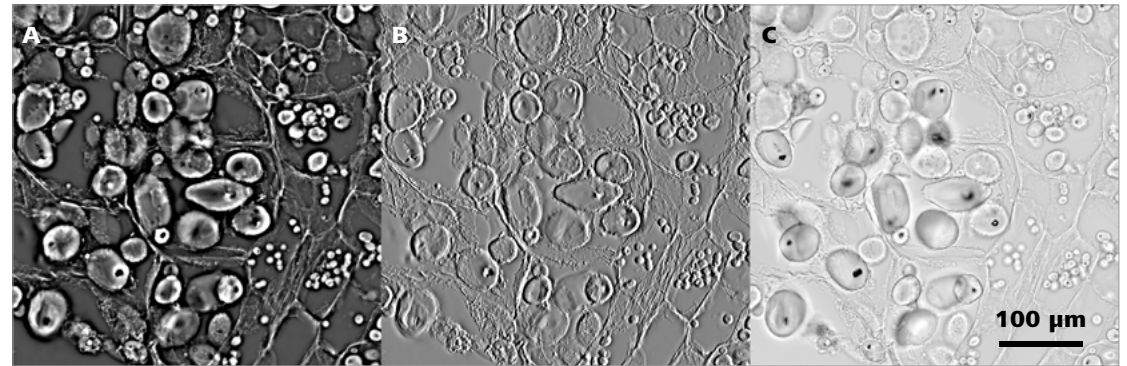

*Solanum tuberosum – potato starch, 20x Plan-Apochromat 0.8; A) TIE phase contrast, B) TIE relief contrast, C) Brightfield*

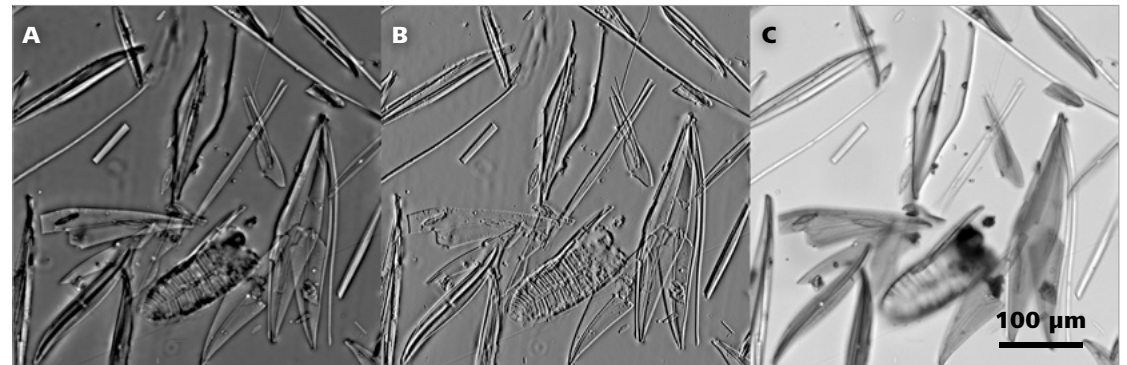

*Pleurosigma angulatum – diatoms, 20x Plan-Apochromat 0.8; A) TIE phase contrast, B) TIE relief contrast, C) Brightfield*



# Your Insight into the Technology Behind It

- › In Brief
- › **The Advantages**
- › The Applications
- › The System
- › Technology and Details
- › Service

## **ZEN Slidescan: Easy to use and versatile**

Advanced imaging software brings real benefits to biomedical research, capably handling your wide-ranging and complex tasks while remaining easy to operate. The Axioscan 7 operating software, ZEN Slidescan, is another expression of the Axioscan philosophy: combining the highest scanning performance and simplest operation with application-specific customization options.

## **Smart setup of scanning tasks**

Easy-to-create scan profiles form the foundation for efficient slide scanning. ZEN Slidescan supports you with intuitive helpers like the new Smart Profile Wizard and the powerful Advanced Profile Editor. Scan profiles even for complex fluorescence imaging tasks can be created quickly. Just choose the dyes and ZEN Slidescan will calculate all the other settings. Once created, you can assign and apply scan profiles to numerous slides with ease.

## **Editing of focus points**

Precise focusing is important for high-quality scanning results. Axioscan 7 automatically focuses the various sample areas on your slides. However, for some demanding applications, it may be necessary to check the position of the focus map support points and adjust them manually. With the new Edit Focus Points feature, you can add and move focus points to regions that are more suitable for focusing, even if those regions are outside the scan area and are not needed for scanning.

## **Seamless imaging and processing**

ZEN Slidescan allows you to not only capture virtual slides but also analyze and process the image data—all on the one platform. ZEN makes your images sharper and smoother, reinforcing contours, contrasts, brightness and color. Meanwhile deconvolution produces crystal clear images that correspond to optical sections, free of out-of-focus light. Easy options for data export enable the analysis with third party tools, in case the CZI image format is not natively supported.

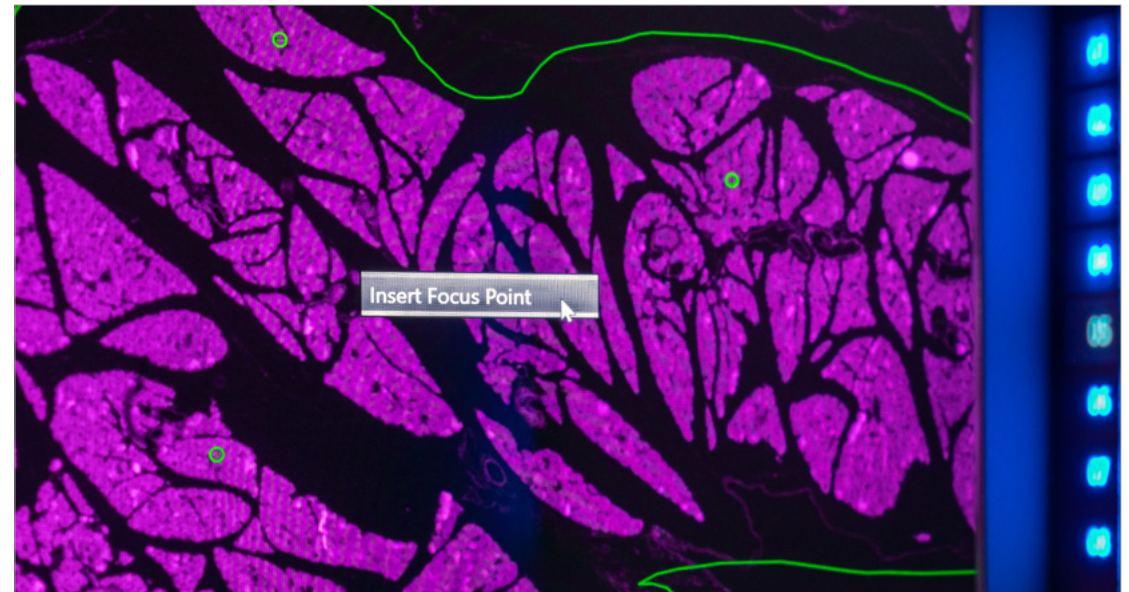

*Editing of focus points*

# Your Insight into the Technology Behind It

- › In Brief
- › **The Advantages**
- › The Applications
- › The System
- › Technology and Details
- › Service

Virtual slides provide you with a multitude of valuable data so you will need plenty of storage space and a good filing structure to achieve high throughput. ZEISS implemented a central solution that manages your data so you can focus on results.

## **ZEN Data Storage: the safe haven for all your imaging data**

ZEN Data Storage forms the central database that holds not only your digitized slides, but also multidimensional ZEN Connect projects. The server software is easily installed on any Windows-based server hardware.

## **ZEN Data Explorer: permanent access to your research results**

ZEN Data Explorer lets you access the stored data from anywhere. Running as a hybrid app on smartphones and tablets (both iOS and Android) as well as in a web browser, ZEN Data Explorer provides access to your data storage and handles even large files efficiently. It will be your companion for sharing your findings at conferences and impressing prospective collaboration partners with your data. You can insert annotations and view images in transmitted light and multichannel fluorescence images with a Z stack.

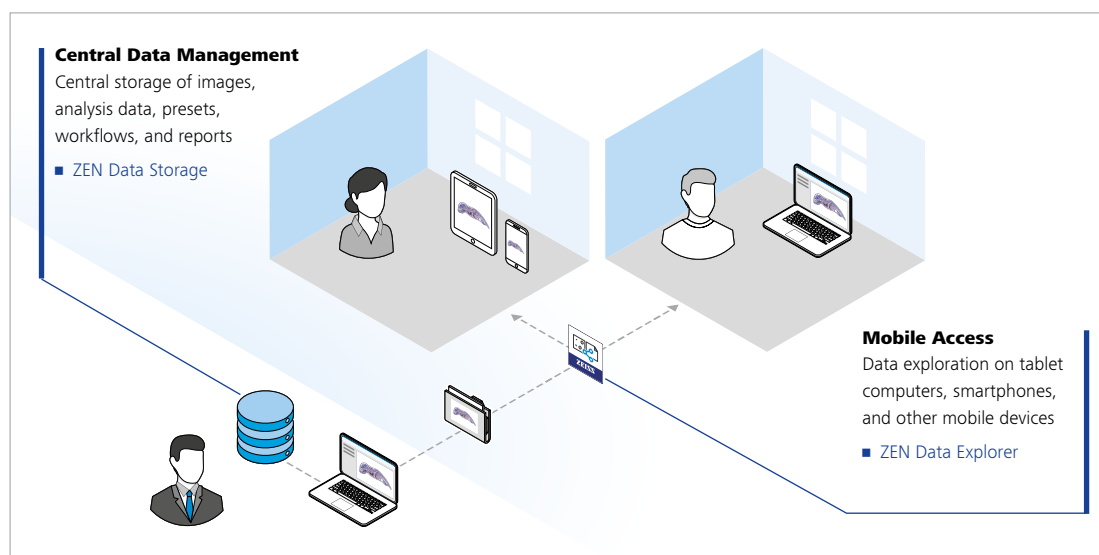

Share data on ZEN Data Storage with students and partners via ZEN Data Explorer.

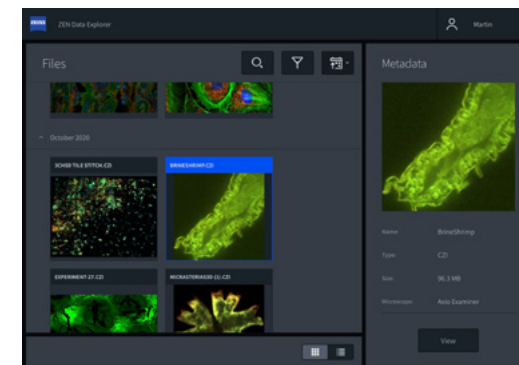

ZEN Data Explorer gallery view

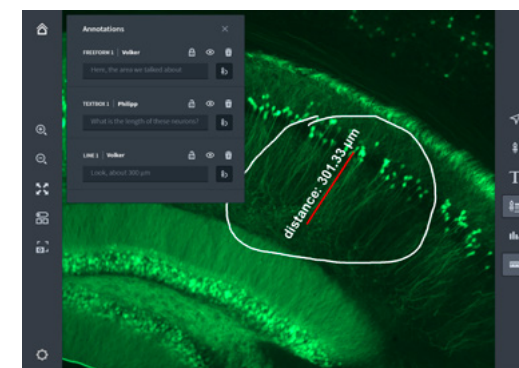

ZEN Data Explorer annotations view

## **CZI data format**

The ZEISS CZI format provides a wealth of benefits and is supported by a growing number of other manufacturers. For an updated list, please visit [www.zeiss.com/czi](http://www.zeiss.com/czi).

# Expand Your Possibilities

- › In Brief
- › **The Advantages**
- › The Applications
- › The System
- › Technology and Details
- › Service

## **Core Imaging Facilities: A sound investment that quickly pays for itself**

In core imaging facilities, the demand for higher throughput and screening capability drives the charge towards automated instruments. Automation is convenient, but some platforms suffer from compromises in flexibility or image quality which will significantly impact the number of users wanting to make use of it.

Axioscan 7 provides automation without sacrificing flexibility or the high quality of images you need to attract a very wide range of users to your facility. With approaches as varied as multiplexing in tissue sections to polarization in rock sections, there is a great opportunity to attract users from departments as diverse as Life Science and Geology. As well as offering flexibility, Axioscan 7 is designed for 24/7 usage. This powerful combination of accommodating a broad user base with robust design places Axioscan 7 as a top performer when it comes to usage hours and it quickly pays for itself.

Axioscan 7 complements the other instruments in your facility and conveniently integrates into time saving workflows. Automatic, high quality screening of hundreds of samples for identification of regions or events of interest is fast and efficient.

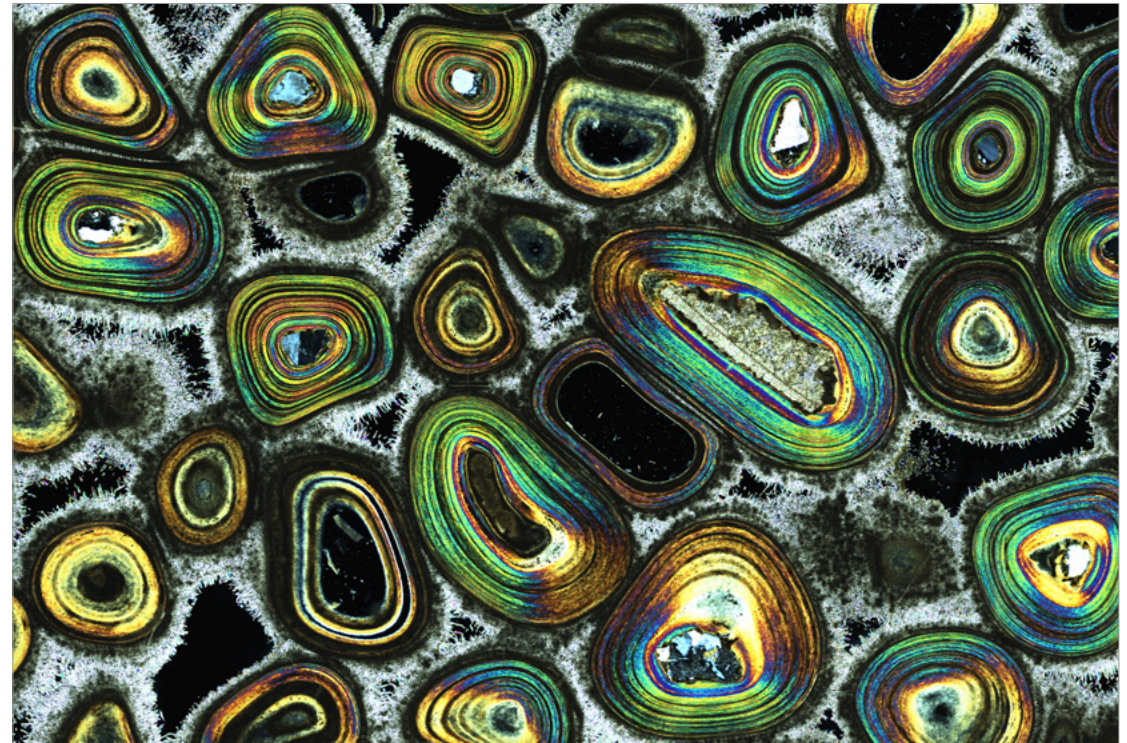

*Thin section of Karlsbader Sprudelstein, scanned with 10x N-Achroplan 0.45 Pol. A merged image of the cross linear polarized light channels is shown. Sample courtesy of Bernardo Cesare, Universita di Padova, Italy*

Subsequent higher magnification acquisitions using other imaging systems in the facility, like confocal systems, are easily guided using ZEN Connect and as such, previously time-consuming studies are reduced in both time and complexity.

Support your users with easy to learn automated scanning that offers great flexibility while requiring minimal training.

# Expand Your Possibilities

- › In Brief
- › **The Advantages**
- › The Applications
- › The System
- › Technology and Details
- › Service

## ZEISS Predictive Service

### Maximizes System Uptime

Once connected to your network and activated, this advanced technology will automatically track the health status of your instrument and collect system log files in the background to improve remote diagnosis.

Relevant technical data such as operating hours, cycle counts or voltages are periodically monitored via a secure connection to our data center. The ZEISS Predictive Service application evaluates the performance of your microscope as system data can be received and analyzed.

Our support engineers will diagnose any issues by analyzing data on the Enterprise Server – remotely and without interruption to your operation.

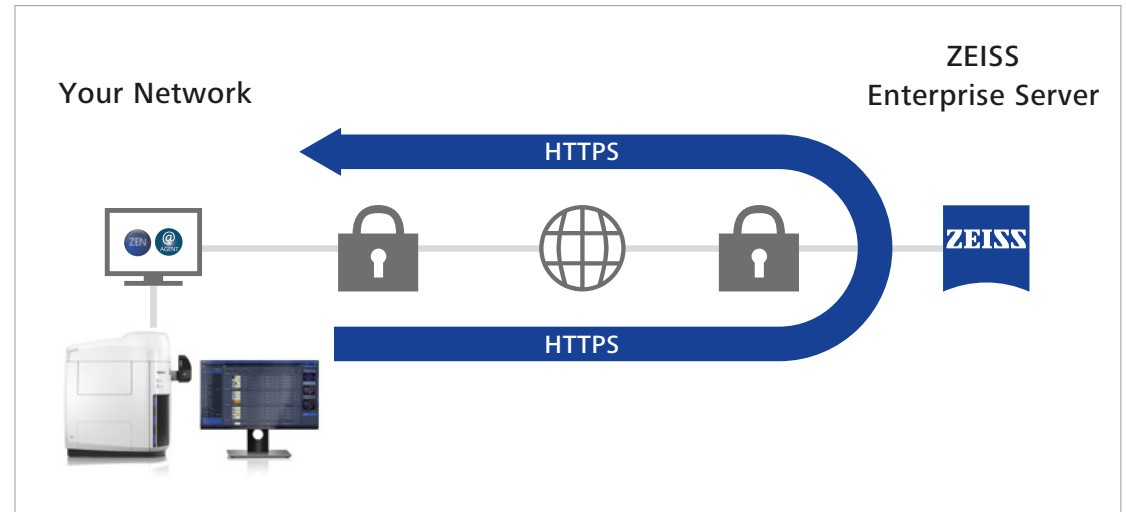

#### ■ **Maintain highest system availability**

Increase your uptime through close monitoring of the system's condition as remote support can often provide immediate solutions.

#### ■ **Data security**

Ensure highest data security standards using well established technologies like PTC Thingworx and Microsoft Azure Cloud. No personal or image data is uploaded, only machine data.

#### ■ **Fast and competent support**

Use secure remote desktop sharing to easily get an expert connected.

#### ■ **Optimum instrument performance**

As the status of your system is monitored, necessary actions can be planned before they become urgent.

# Tailored Precisely to Your Applications

- › In Brief
- › The Advantages
- › **The Applications**
- › The System
- › Technology and Details
- › Service

Typical Applications / Typical Samples	Task	ZEISS Axioscan 7 Offers
Research on Alzheimer pathogenesis and other age-related diseases	Developing analytical models for amyloid deposition (plaques)	High-resolution virtual slides in brightfield with image analysis
Cancer research	Researching the basics of cancer	Excellent image quality in fluorescence combined with high throughput thanks to fast filter wheels and sensitive cameras
Multiplexed imaging	Identifying phenotypic fingerprints of different tissue types	Optimal spectral separation of up to 7 fluorescent dyes thanks to newly designed filter sets
Collagen organization	Analyzing fiber orientation using polarization light microscopy	Extensive choice of different polarization options (circular polarization, multi-angle cross polarization)
ADME / Toxicology	Automated image analysis workflow and peer reviews with colleagues at other locations	Findings are reproducible thanks to automated calibration, image analysis, and remote viewing
Fluorescence in-situ hybridization (FISH)	Determining the number of single sequence copies in the genome	Multichannel fluorescence, extended depth of field
Target identification and characterization	Identifying and characterizing targets for pharmaceutical active substance searches	Sensitive fluorescence imaging combined with gentle treatment of specimens, especially in combination with TIE contrast focusing options; image analysis functions
Immunological response to allografts and xenografts	Identifying specific cell phenotypes and developing an understanding of cellular interactions in tissues	High dynamic range and zero artifact imaging
Research in the area of neurotraumas	Quantifying brain injury measurements, including functional pathways of regeneration and microglia	Z stack imaging and robust digitization of the samples with high throughput
Tissue microarrays (TMA)	Resource-friendly use of reagents and tissues with increased throughput	Reliable sample detection and robust scanning process
Contract research in the biomedical field	Use of slides that are hard to standardize and various applications	Flexible and configurable imaging options and tray concept
Organization of expert networks	Organizing the efficient exchange of information from experts around the world (e.g., cancer centers, tumor databases)	Database with integrated platform-independent access to images and documents
Inter-study group information management	Sustained organization of the data pool in local study groups and evaluation of research findings	Multi-user access to database with specific access rights
Exchange of information during spur of the moment discussions/meetings	Discussing findings with peers spontaneously, irrespective of location	Excellent image quality, remote data access with smartphones and tablet computers
Publishing projects online	Making own data and images accessible to other people	Project-based web-centric database system with integrated web-viewing

# ZEISS Axioscan 7 at Work

- › In Brief
- › The Advantages
- › **The Applications**
- › The System
- › Technology and Details
- › Service

ZEISS Axioscan 7 offers reliably reproducible image quality, no matter if you repeat your imaging task after a day, a week, a month or on a different machine.

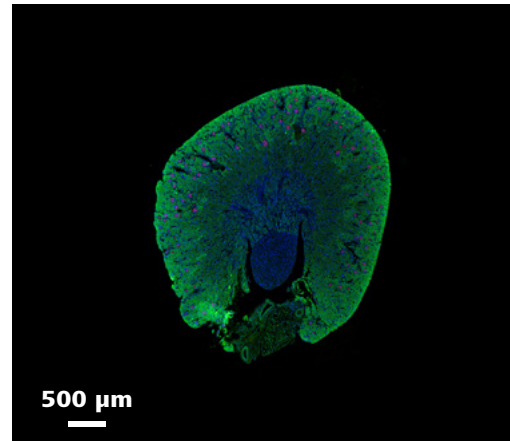
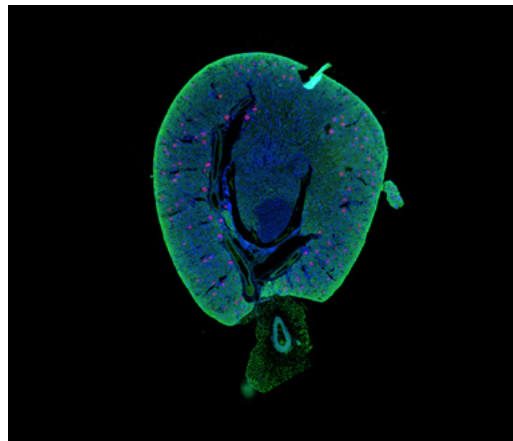
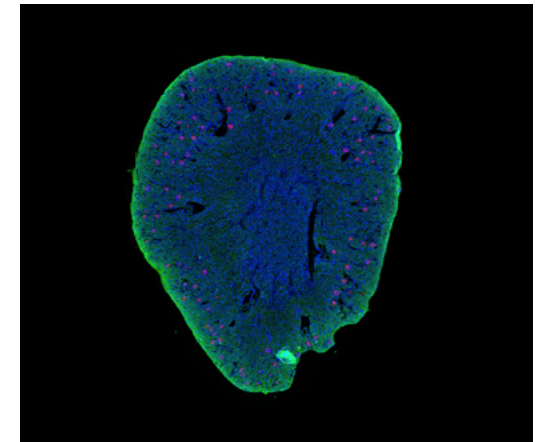
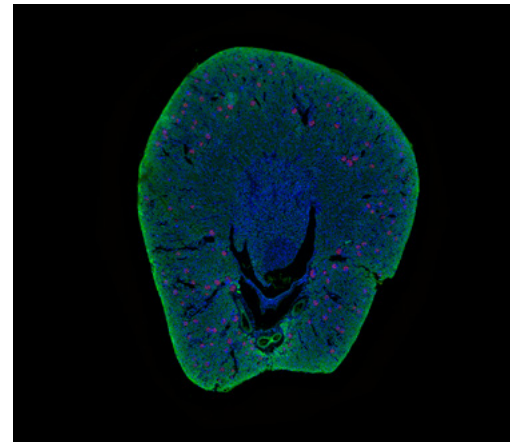
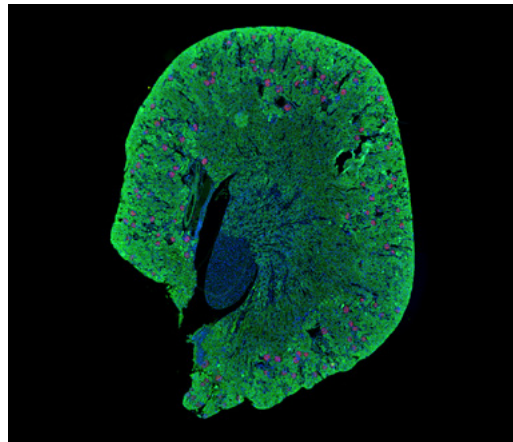

*Paraffin-embedded mouse kidneys from healthy wildtype animals (12 weeks). Nephrin stained with Cy3. PCNA APC (FarRed) and DAPI as counterstaining. Imaged with 20× NA 0.8 objective. Sample courtesy: Florian Gemhardt, Experimental Nephrology, Department of Internal Medicine III, University Clinic Carl Gustav Carus Dresden, Germany*

## ZEISS Axioscan 7 at Work

- › In Brief
- › The Advantages
- › **The Applications**
- › The System
- › Technology and Details
- › Service

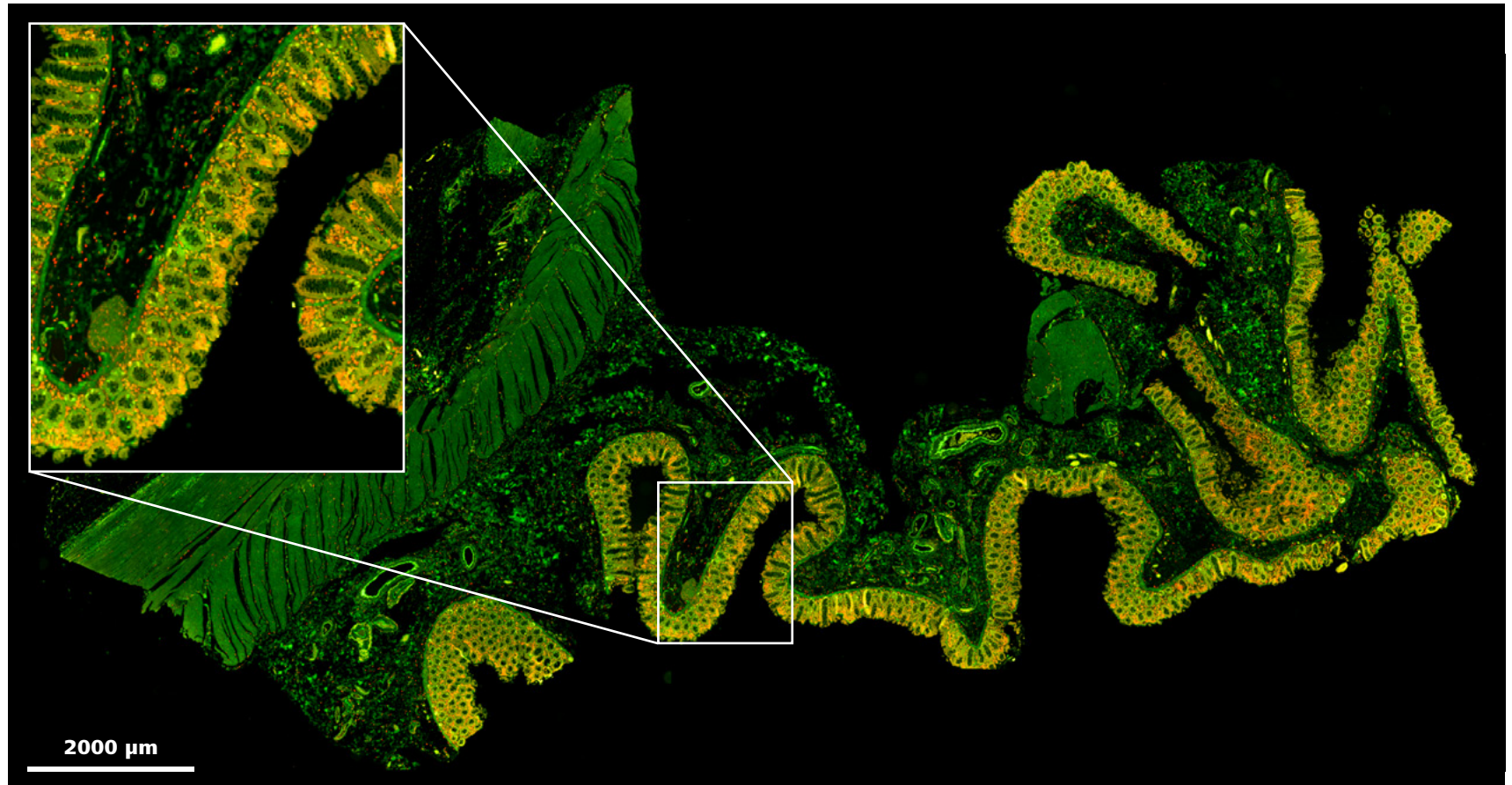

Colon sample from a patient with Crohn's disease, imaged with 20x NA 0.8 objective.

Green: Cox-1 in Tuft cells in the epithelium – the sensory cells of the gut – and cells in the lamina propria connective tissue. Red: CD 163 – a macrophage marker.

Courtesy of Steen Seier Poulsen, Department of Endocrinology and Metabolism, University of Copenhagen, Denmark.

The image shown on this page represents research content. ZEISS explicitly excludes the possibility of making a diagnosis or recommending treatment for possibly affected patients on the basis of the information generated with an Axioscan 7 slide scanner.

# ZEISS Axioscan 7 at Work

- › In Brief
- › The Advantages
- › **The Applications**
- › The System
- › Technology and Details
- › Service

The UltiMapper I/O PD-L1 kit from Ultivue addresses whether a tumor is “hot” or “cold” and responsive to immune checkpoint inhibition because of a high immune infiltrate (hot), in contrast to tumors with low immune infiltrates called “cold tumors” or non-T-cell-inflamed cancers – by exploring multiple cell phenotypes such as cytotoxic immune cells (CD8), immunosuppressive macrophages (Markers CD68, PD-L1) or immune evading tumor cells (Markers CK, PD-L1).

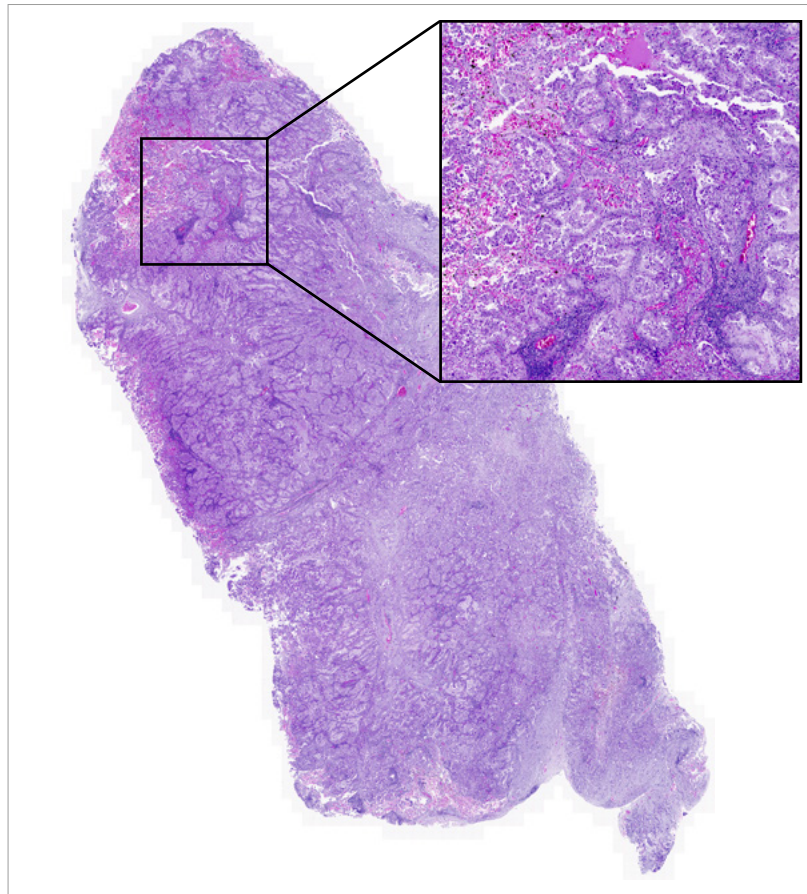

H&E stain of Non-small cell lung cancer (NSCLC) tissue.  
Sample courtesy of Ultivue, Inc. Cambridge, Massachusetts, USA

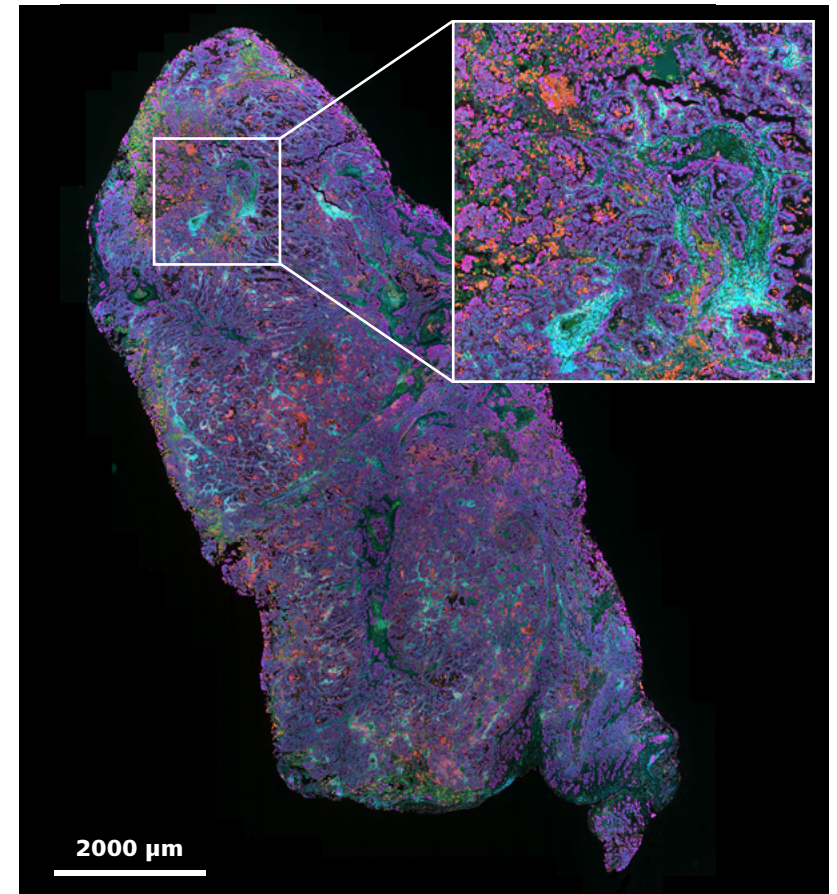

NSCLC tissue stained with UltiMapper I/O PD-L1 kit. Nuclear counterstain (blue), CD8 (green), CD68 (orange), PD-L1 (red), panCytoKeratin (magenta).

The images shown on this page represent research content. ZEISS explicitly excludes the possibility of making a diagnosis or recommending treatment for possibly affected patients on the basis of the information generated with an Axioscan 7 slide scanner.



# Your Flexible Choice of Components

- › In Brief
- › The Advantages
- › The Applications
- › **The System**
- › Technology and Details
- › Service



## 1 Microscope

- Axioscan 7
- Magazines for 12 or 100 slides
- Trays for four 26 mm × 77 mm slides, two 52 mm × 77 mm slides or 28 mm × 48 mm and 106 mm × 77 mm slides

## 2 Objectives

- Fluor (5×)
- N-Achroplan Pol (5×, 10×, 20×)
- Plan-Apochromat (10×, 20×, 40×)
- EC Plan-Neofluar Pol (20×, 40×)
- EC Epiplan-Neofluar Pol (5×, 10×, 20×, 50×)
- Other objectives on request

## 3 Illumination

- Transmitted light: WL-LED
- Fluorescence: Colibri 7 (385 nm, 430 nm, 475 nm, 511 nm, 555 nm, 590 nm, 630 nm, 735 nm) or X-Cite Xylis LT720L (380 nm – 770 nm)
- Filter wheels:
  - 10-position ACR for filter cubes or
  - 6-position high-speed excitation
  - 6-position high-speed beamsplitter
  - 6-position high-speed emission

## 4 Cameras

- AxioCam 705 color
- AxioCam 712 mono
- Hamamatsu ORCA-Flash 4.0

## 5 Software

- ZEN Slidescan
- ZEN lite
- ZEN Data Storage
- ZEN Data Explorer

# System Overview

- › In Brief
- › The Advantages
- › The Applications
- › **The System**
- › Technology and Details
- › Service

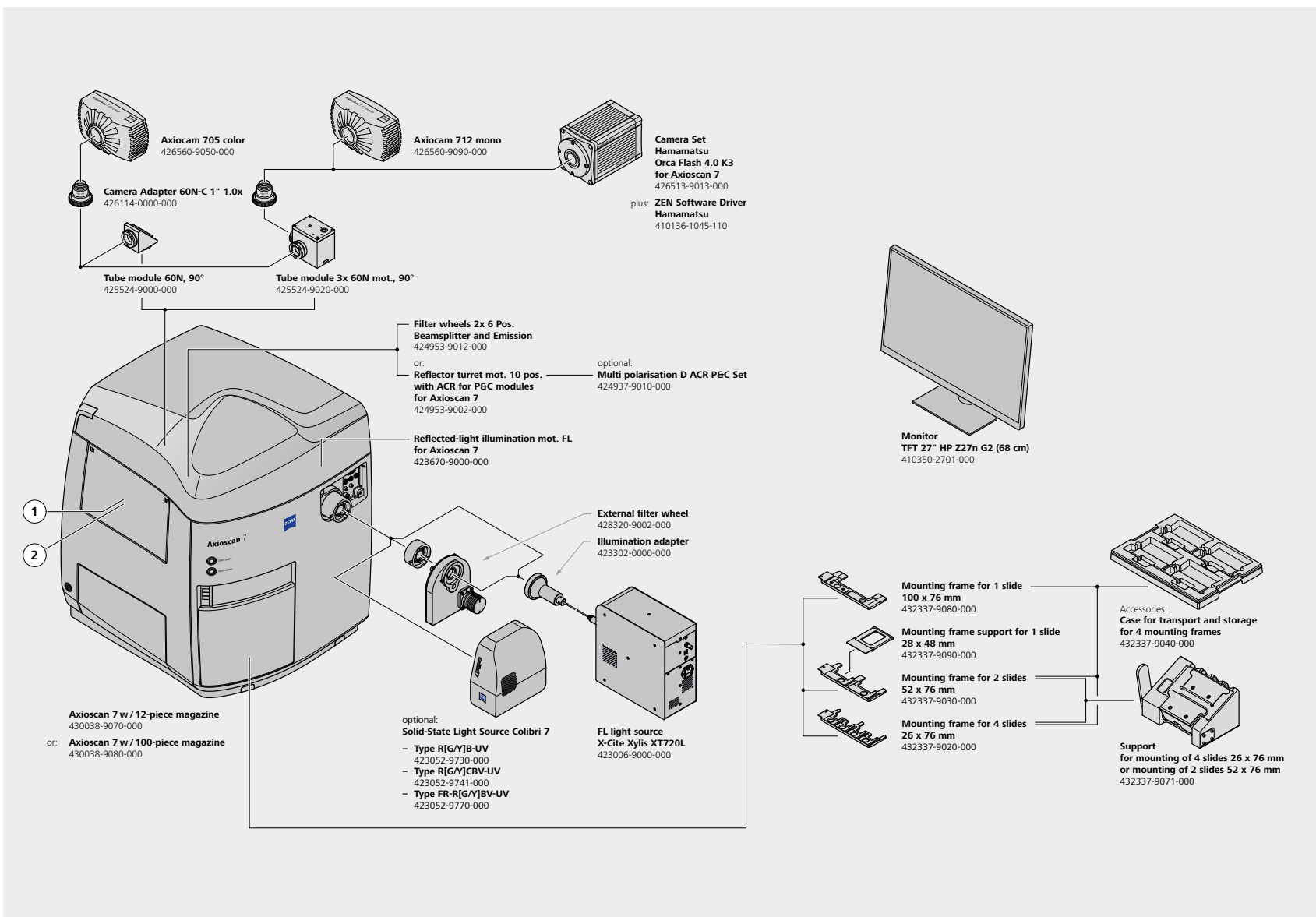

# System Overview

- › In Brief
- › The Advantages
- › The Applications
- › **The System**
- › Technology and Details
- › Service

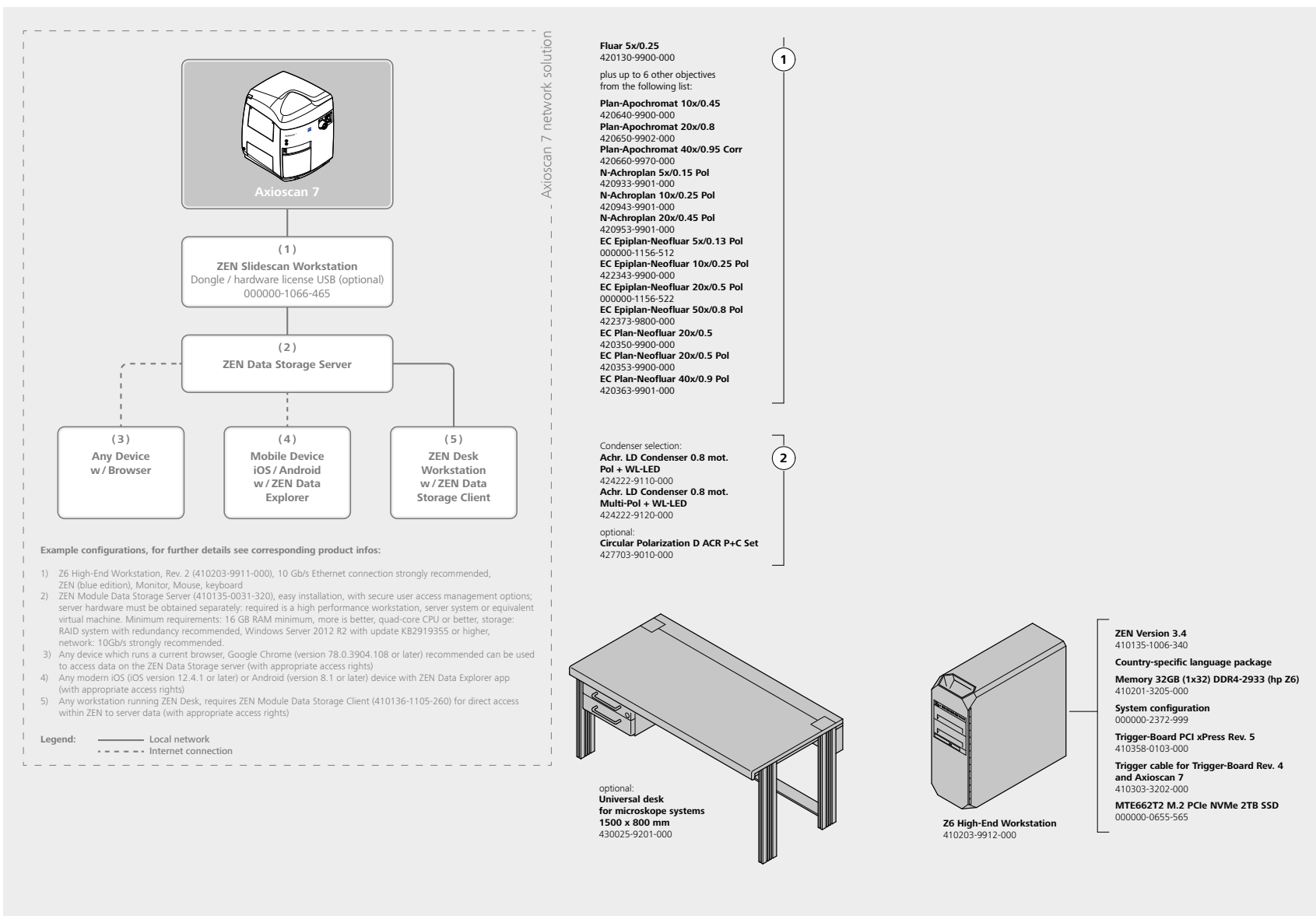

# Technical Specifications

- › In Brief
- › The Advantages
- › The Applications
- › The System
- › **Technology and Details**
- › Service

## Dimensions (width × depth × height)

Axioscan 7 (brightfield)	Approx. 695 mm × 579 mm × 813 mm
Axioscan 7 (brightfield and fluorescence with Colibri 7)	Approx. 912 mm × 579 mm × 813 mm

## Mass

Axioscan 7 (brightfield, 12 slides)	Approx. 100 kg
Axioscan 7 (brightfield and fluorescence with Colibri 7 and 100 slides)	Approx. 115 kg

## Environmental conditions for transport (in packaging)

Permissible ambient temperature	-35 °C to +60 °C
---------------------------------	------------------

## Storage

Permissible ambient temperature	-10 °C to +55 °C
Permissible relative humidity (without condensation)	Max. 90 % at 55 °C

## Operation

Permissible ambient temperature	+10 °C to +30 °C (with X-Cite Xylis: +15 °C to +30 °C)
Permissible relative humidity	Max. 75 % at 30 °C
Highest permitted altitude of use	Max. 2000 m
Atmospheric pressure	800 hPa to 1060 hPa
Degree of pollution	2

## Operating data

Operational area	Closed rooms
Protection class	I
Electrical safety	Conforming to DIN EN 61010-1 (IEC 61010-1), DIN EN 61010-2-101 (IEC 61010-1 and IEC 61010-2-101) in CSA and UL regulations
Overvoltage category	II
RFI suppression	Conforming to EN 55011 class A
Noise immunity	Conforming to DIN EN 61326-1 and DIN EN 61326-2-6
Input voltage, basic unit (Mains voltage does not need to be converted!)	100 V AC to 240 V AC
Power frequency	50 / 60 Hz
Power consumption	Max. 260 VA
Fuses	2× T 5.0A / H 250V, 5 × 20 mm; 1× T 5.0A 250V 6 × 32 mm

# Technical Specifications

- › In Brief
- › The Advantages
- › The Applications
- › The System
- › **Technology and Details**
- › Service

## Pixel resolution (Axiocam 712 mono / Axiocam 705 color)

10x	0.345 $\mu\text{m}$ /pixel
20x	0.173 $\mu\text{m}$ /pixel
40x	0.086 $\mu\text{m}$ /pixel

## Reflector turret

Reflector turret with ACR for push and click filter sets

Number of positions	10
Type	Optically encoded (no detents)
Switching time	Approx. 400 ms (between neighboring positions)

## High-speed filter wheels for single filter or beamsplitter

Number of positions	6
Type	Optically encoded (no detents)
	Separate control of excitation, beamsplitter and emission filter wheel
Switching time	Approx. 50 ms (between neighboring positions)

## Motorized condenser modulator disk

Number of positions	4
---------------------	---

## Contrasting techniques

Transmitted light brightfield
Transfer of Intensity Equation (TIE)
Transmitted light polarization (linear, crossed linear, circular)
Reflected light fluorescence
Reflected light brightfield

# Technical Specifications

- › In Brief
- › The Advantages
- › The Applications
- › The System
- › **Technology and Details**
- › Service

Light sources		
Transmitted light	WL-LED (wavelength: 400 to 700 nm, maximum at 460 nm)	
Fluorescence	Colibri 7 (wavelength: 385 nm, 430 nm, 475 nm, 511 nm, 555 nm, 590 nm, 630 nm, 735 nm); X-Cite Xylis LT720L (wavelength: 380 nm to 770 nm)	
Thumbnail generation		
Labeling area	Separate camera with reflected light illumination	
Specimen area (brightfield)	Separate camera with transmitted light illumination	
Specimen area (fluorescence)	5× objective with transmitted light illumination (TIE) or reflected light illumination (fluorescence)	
Z stack		
Imaging of Z stacks and application of extended depth of field function		
Bar codes and optical character recognition		
1D barcode types		
Australian Post	Industrial 2of5	RSS 14 Truncated
Code 11	MSI	RSS 14 Limited
Code 39 (Code 3of9)	PatchCode	RSS 14 Expanded
Code 93	Planet	RSS 14 Stacked
Code 128 (UCC/EAN128)	Postnet	RSS 14 Stacked Omni
Codabar	Plus2 (EAN-EXT-2)	RSS 14 Expanded Stacked
Code Interleaved 2of5	Plus5 (EAN-EXT-5)	UPC-A
EAN-8	Royal Mail	UPC-E
EAN-13	RSS 14	USPS OneCode
2D barcode types		
Aztec	MicroPDF417	
Datamatrix	Micro QR Code	
■ Numeric encoding	PDF417 (Standard encoding type)	
■ Alpha encoding	QR Code (QR code Model 1, 2 encoding)	
■ AlphaNumericPunc encoding		
■ AlphaNumeric encoding		
■ ASCII encoding		
■ IS08 encoding		
Maxi		
Optical Character Recognition (OCR)		
The following fonts are supported: American Typewriter, Arial, Bodoni, Bookman, Calibri, Courier, DIN 1451, Eurostyle, FF DIN, Fixed, Fixedsys, Frutiger, Letter Gothic, MS Sans Serif, OCR A, OCR B, Prestige, Segoe UI, Times New Roman, Verdana		
Compression		
Lossless or lossy with JPEGXR (quality can be adjusted)		
Optional software components		
Image analysis	ZEN (blue edition) image analysis modules	
Database and remote viewing	ZEN Data Storage, ZEN Data Explorer	
Image viewing	ZEN lite (freeware)	

# Technical Specifications

- › In Brief
- › The Advantages
- › The Applications
- › The System
- › **Technology and Details**
- › Service

<b>Magazine</b>			
Capacity	12 slides (26 mm × 77 mm)	100 slides (26 mm × 77 mm)	
Tray	for 4 slides (26 mm × 77 mm)	for 2 slides (52 mm × 77 mm or 28 mm × 48 mm)	for 1 slide (106 mm × 77 mm)
Usable slides	Length	Width	Thickness
26 mm × 77 mm (DIN ISO 8037/1 and A-A 50831)	73.5 mm ... 76.5 mm	24.0 mm ... 26.0 mm	0.8 mm ... 1.3 mm
52 mm × 77 mm (DIN ISO 8037/1)	73.5 mm ... 76.5 mm	50.0 mm ... 52.0 mm	0.8 mm ... 1.3 mm
106 mm × 77 mm	73.5 mm ... 76.5 mm	99.0 mm ... 106.0 mm	0.8 mm ... 1.3 mm
28 mm × 48 mm	26.0 mm ... 28.2 mm	46.0 mm ... 48.2 mm	1.0 mm ... 1.6 mm
Other dimensions on request			
<b>Speed</b>			
Brightfield 10×10 mm, 20×, Axiocam 705 color	1:13 minutes (pure scan time)		
Fluorescence 10×10 mm, 20×, Axiocam 712 mono, 4 FL channels (10 ms exposure each)	5:23 minutes (pure scan time)		
<b>Objectives</b>			
Number of usable objectives	Up to 7 with automatic switching		
<b>List of usable objectives (other objectives on request)</b>			
Fluar (5×)	EC Plan-Neofluar Pol (20×, 40×)		
N-Achroplan Pol (5×, 10×, 20×)	EC Epiplan-Neofluar Pol (5×, 10×, 20×, 50×)		
Plan-Apochromat (10×, 20×, 40×)			
<b>Cameras</b>			
Number of cameras	Up to 2 with automatic switching		
<b>List of usable cameras</b>			
Axiocam 705 color (brightfield)			
Axiocam 712 mono (fluorescence)			
Hamamatsu ORCA-Flash 4.0 (fluorescence)			



## ZEISS Service – Your Partner at All Times

Your microscope system from ZEISS is one of your most important tools. For over 175 years, the ZEISS brand and our experience have stood for reliable equipment with a long life in the field of microscopy. You can count on superior service and support - before and after installation. Our skilled ZEISS service team makes sure that your microscope is always ready for use.

- › In Brief
- › The Advantages
- › The Applications
- › The System
- › Technology and Details
- › **Service**

### Procurement

- Lab Planning & Construction Site Management
- Site Inspection & Environmental Analysis
- GMP-Qualification IQ/OQ
- Installation & Handover
- IT Integration Support
- Startup Training

### Operation

- Predictive Service Remote Monitoring
- Inspection & Preventive Maintenance
  - Software Maintenance Agreements
    - Operation & Application Training
    - Expert Phone & Remote Support
  - Protect Service Agreements
    - Metrological Calibration
      - Instrument Relocation
        - Consumables
        - Repairs

### New Investment

- Decommissioning
- Trade In

### Retrofit

- Customized Engineering
  - Upgrades & Modernization
- Customized Workflows via ZEISS arivis Cloud



Please note: Availability of services depends on product line and location

>> [www.zeiss.com/microservice](http://www.zeiss.com/microservice)





**Carl Zeiss Microscopy GmbH**

07745 Jena, Germany

[microscopy@zeiss.com](mailto:microscopy@zeiss.com)

[www.zeiss.com/axioscan-bio](http://www.zeiss.com/axioscan-bio)